

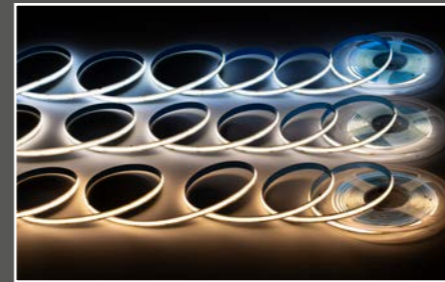
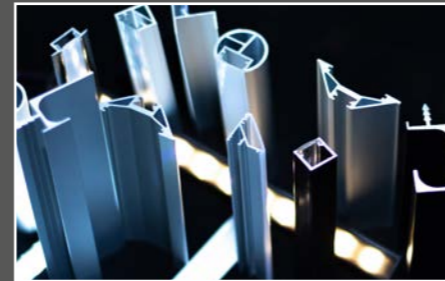

 DesignLight

PROFILE
ARCHITEKTONICZNE
ARCHITECTURAL PROFILES

O nas 

Jako firma produkcyjno-handlowa posiadamy wieloletnie doświadczenie. **Specjalizujemy się w produkcji oraz sprzedaży zaawansowanych systemów LED do mebli i mieszkań.** W naszym bogatym asortymencie znajdują Państwo wszystko to, co niezbędne, aby rozświetlić dom w efektywny, ale również energooszczędny sposób.

Zaopatrujemy największe hurtownie akcesoriów meblowych w Polsce oraz za granicą w nowoczesne i ekologiczne oświetlenie LED. **Posiadamy odpowiednie zaplecze techniczne dzięki, któremu jesteśmy w stanie produkować własne oświetlenie i akcesoria takie jak profile, oprawy LED, płytki SMD oraz inteligentne wyłączniki LED.**

Dysponujemy obszernym i nowoczesnym magazynem oraz halą produkcyjną o łącznej powierzchni około 3000 m² oraz 3500 miejsc paletowych. Dzięki komputeryzacji procesów magazynowych jesteśmy w stanie szybko reagować. Każdą wysyłkę traktujemy priorytetowo, ponieważ satysfakcja klienta jest wyznacznikiem jakości naszej pracy. Oferujemy doradztwo, pomoc techniczną oraz fachową obsługę przed i posprzedażową. Satysfakcja naszych partnerów jest źródłem inspiracji. Stanowi wskazówkę dla naszych obecnych i przyszłych działań.

Design Light – kreujemy jasną przyszłość wewnątrz.

About us 

As a manufacturing and trading company we have many years of experience. **We specialize in the production and sale of advanced LED lighting systems for furniture and apartments.** In our wide assortment you will find everything what is necessary to illuminate the house in an effective, but still energy-efficient way.

We supply the largest furniture accessories wholesalers in Poland and abroad in modern and environmentally friendly LED lighting. **Design Light has proper technical facilities through which we are able to produce our own lighting and accessories such as profiles, LED luminaires, SMD plates and intelligent LED switches.**

Our warehouse and production hall is spacious and modern as it offers storage capacity of 3000 m² and 3500 pallet places. Thanks to the computerization of warehouse processes we are able to respond quickly. We treat each consignment priority, because customer satisfaction is a determinant of our quality of work. We offer consulting, technical assistance and professional service before and after-sales. The satisfaction of our partners is a source of inspiration. It provides guidance for our present and future action.

Design Light – we create a bright future for interiors design.

Profil aluminiowy DEOLINE P Aluminum profile DEOLINE P.....	4
Profil aluminiowy DEOLINE XL P Aluminum profile DEOLINE XL P.....	5
Profil aluminiowy DEOLINE W Aluminum profile DEOLINE W.....	6
Profil aluminiowy DEOLINE Z Aluminum profile DEOLINE Z.....	7
Profil aluminiowy DEOLINE C Aluminum profile DEOLINE C.....	8
Profil aluminiowy DEOLINE J Aluminum profile DEOLINE J.....	9
Profil aluminiowy CERAMIC LINE K Aluminum profile CERAMIC LINE K.....	10
Profil aluminiowy CERAMIC LINE P Aluminum profile CERAMIC LINE P.....	11
Profil aluminiowy CERAMIC LINE W Aluminum profile CERAMIC LINE W.....	12
Profil aluminiowy CERAMIC LINE Z Aluminum profile CERAMIC LINE Z.....	13
Profil aluminiowy FOBOS Aluminum profile FOBOS.....	14
Profil aluminiowy FOBOS XL Aluminum profile FOBOS XL.....	15
Profil aluminiowy JAPET Aluminum profile JAPET.....	16
Profil aluminiowy JAPET XL Aluminum profile JAPET XL.....	17
Profil aluminiowy NARVI Aluminum profile NARVI.....	18
Lampa LED BROOKLYN LED lamp BROOKLYN.....	19
Oprawa LED LUMI FLOW LED luminaire LUMIFLOW.....	20
Akcesoria Accessories.....	21

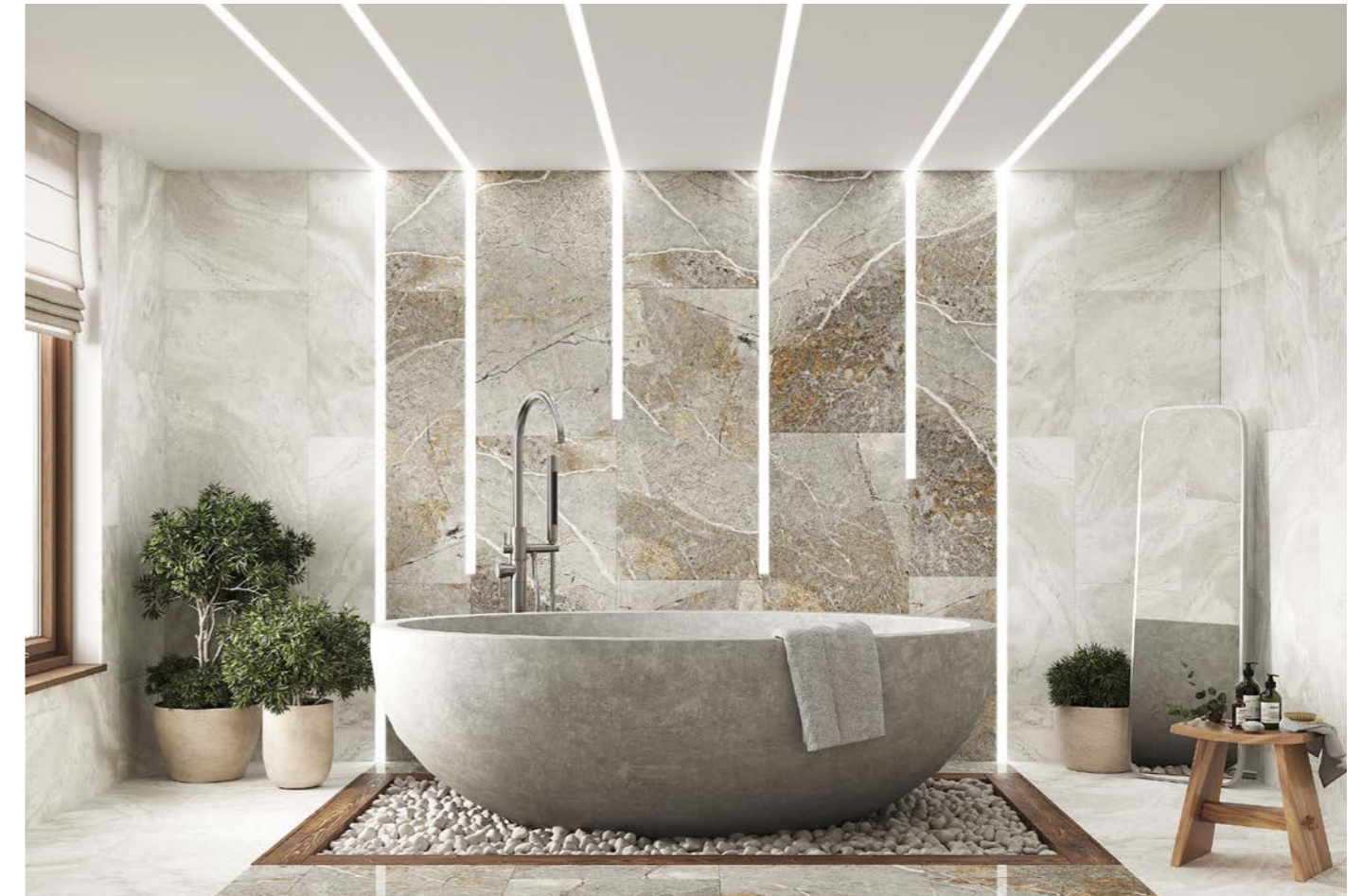

Profil aluminiowy DEOLINE P 2 m, 3 m*
Aluminum profile DEOLINE P 2 m, 3 m**

PROFIL-DEOLINE-P-OP-(2M/3M)-W
PROFIL-DEOLINE-P-CZ-(OP/CZ)-(2M/3M)-W

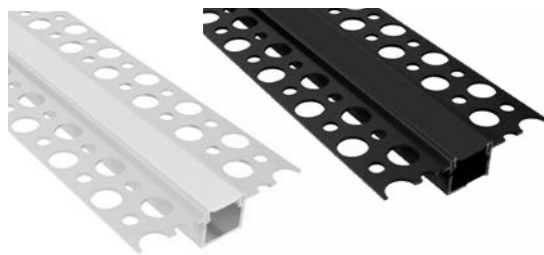

Profil aluminiowy DEOLINE P to profil do płyt gipsowo-kartonowych. Przeznaczony do taśm LED o maksymalnej szerokości 10 mm.

Architectural profile DEOLINE P for plasterboard. Designed for LED strips with a maximum width of 10 mm.

AL CZ

Rysunek techniczny:
Technical drawing:

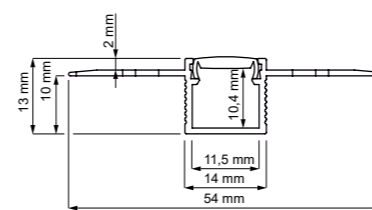

Schemat montażu:
Assembly instruction:

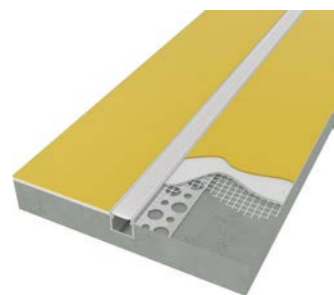

OP2-ZASL-13x14-SZ-02



OP2-ZASL-13x14-CZ-02

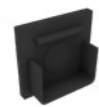

OP2-ZASL-13x14-SZ-02W



OP2-ZASL-13x14-CZ-03W

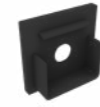

www.designlight.pl



www.designlight.eu



*Tolerancja długości profili i kloszy wynosi +/- 2 mm.
**The tolerance of the length of profiles and diffusers is +/- 2 mm.

Profil aluminiowy DEOLINE XL P 2 m, 3 m*
Aluminum profile DEOLINE XL P 2 m, 3 m**

PROF-DEOLINEXL-AL-OP-(2M/3M)



Profil aluminiowy DEOLINE XL P to profil do płyt gipsowo-kartonowych. Przeznaczony do montażu dwóch taśm LED o maksymalnej szerokości do 12 mm.

Architectural profile DEOLINE XL P for plasterboard. Designed for two LED strips with a maximum width of 12 mm.

AL

Rysunek techniczny:
Technical drawing:

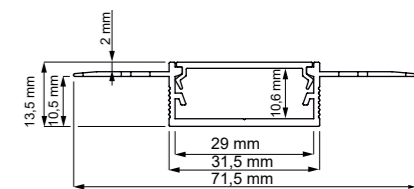

Schemat montażu:
Assembly instruction:

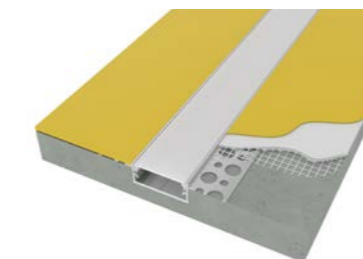

OP2-ZASL-DEOLINEXL-SZ-01



www.designlight.pl



www.designlight.eu



*Tolerancja długości profili i kloszy wynosi +/- 2 mm.
**The tolerance of the length of profiles and diffusers is +/- 2 mm.

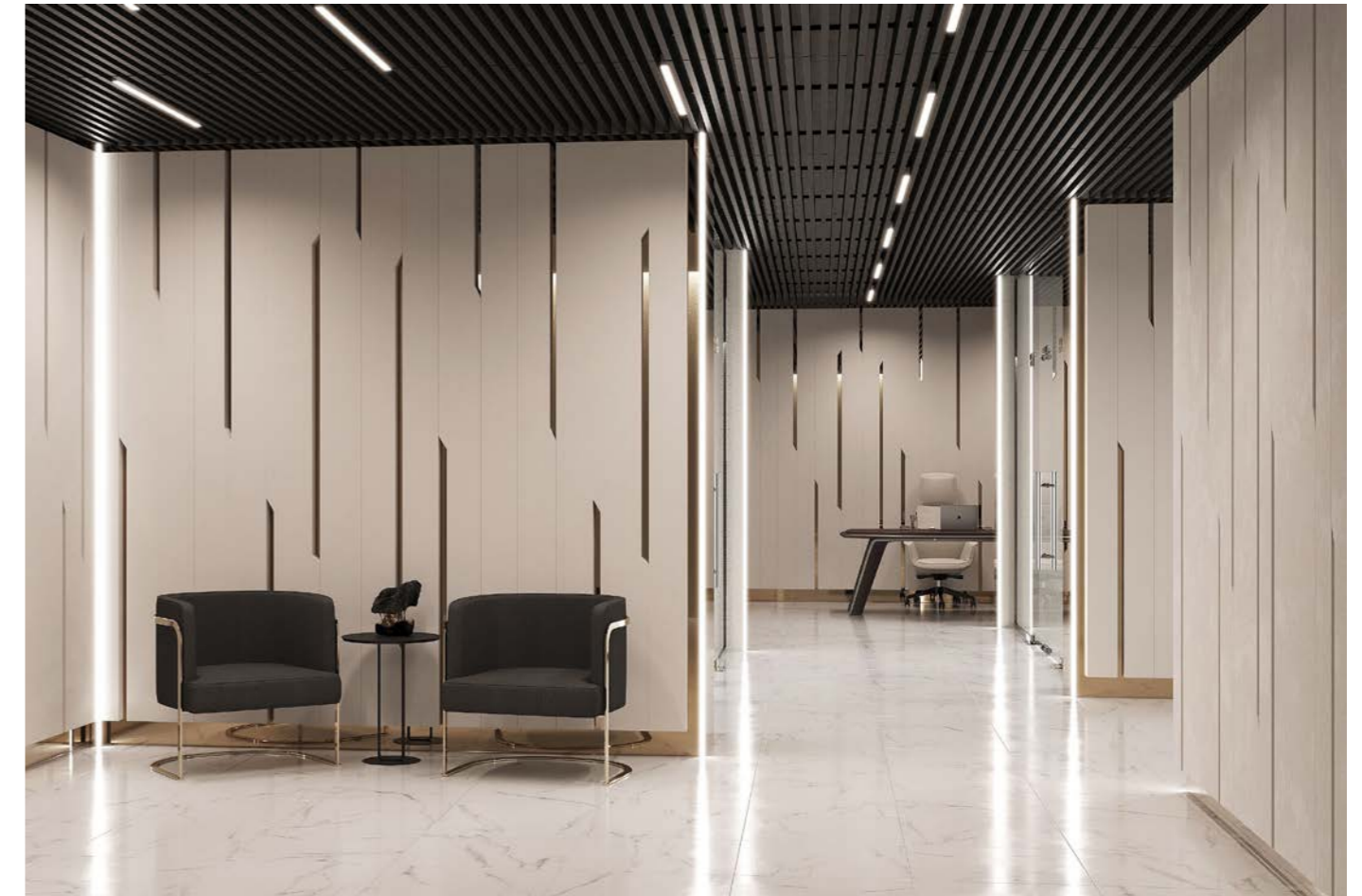

Profil aluminiowy DEOLINE W 2 m, 3 m*
Aluminum profile DEOLINE W 2 m, 3 m**

PROFIL-DEOLINE-W-OP-(2M/3M)-W



Profil aluminiowy DEOLINE W to profil kątowny do płyt gipsowo-kartonowych. Profil przeznaczony do taśm LED o maksymalnej szerokości 10 mm.

Architectural profile DEOLINE W for plasterboard. Designed for LED strips with a maximum width of 10 mm.

AL

Rysunek techniczny:
Technical drawing:

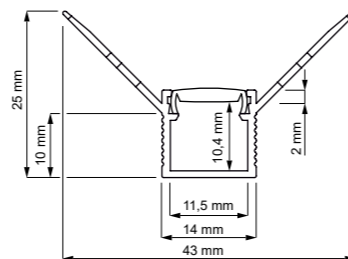

Schemat montażu:
Assembly instruction:

OP2-ZASL-13x14-SZ-02

OP2-ZASL-13x14-SZ-02W



www.designlight.pl



www.designlight.eu



*Tolerancja długości profili i kloszy wynosi +/- 2 mm.
**The tolerance of the length of profiles and diffusers is +/- 2 mm.

Profil aluminiowy DEOLINE Z 2 m, 3 m*
Aluminum profile DEOLINE Z 2 m, 3 m**

PROFIL-DEOLINE-Z-OP-(2M/3M)-W



Profil aluminiowy DEOLINE Z to profil kątowny do płyt gipsowo-kartonowych. Profil przeznaczony do taśm LED o maksymalnej szerokości 10 mm.

Architectural profile DEOLINE Z for plasterboard. Designed for LED strips with a maximum width of 10 mm.

AL

Rysunek techniczny:
Technical drawing:

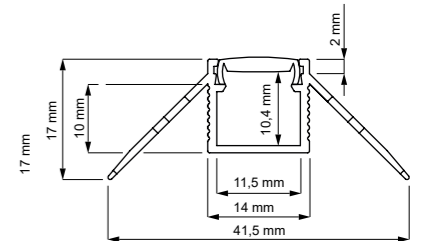

Schemat montażu:
Assembly instruction:

OP2-ZASL-13x14-SZ-02

OP2-ZASL-13x14-SZ-02W



www.designlight.pl



www.designlight.eu



*Tolerancja długości profili i kloszy wynosi +/- 2 mm.
**The tolerance of the length of profiles and diffusers is +/- 2 mm.

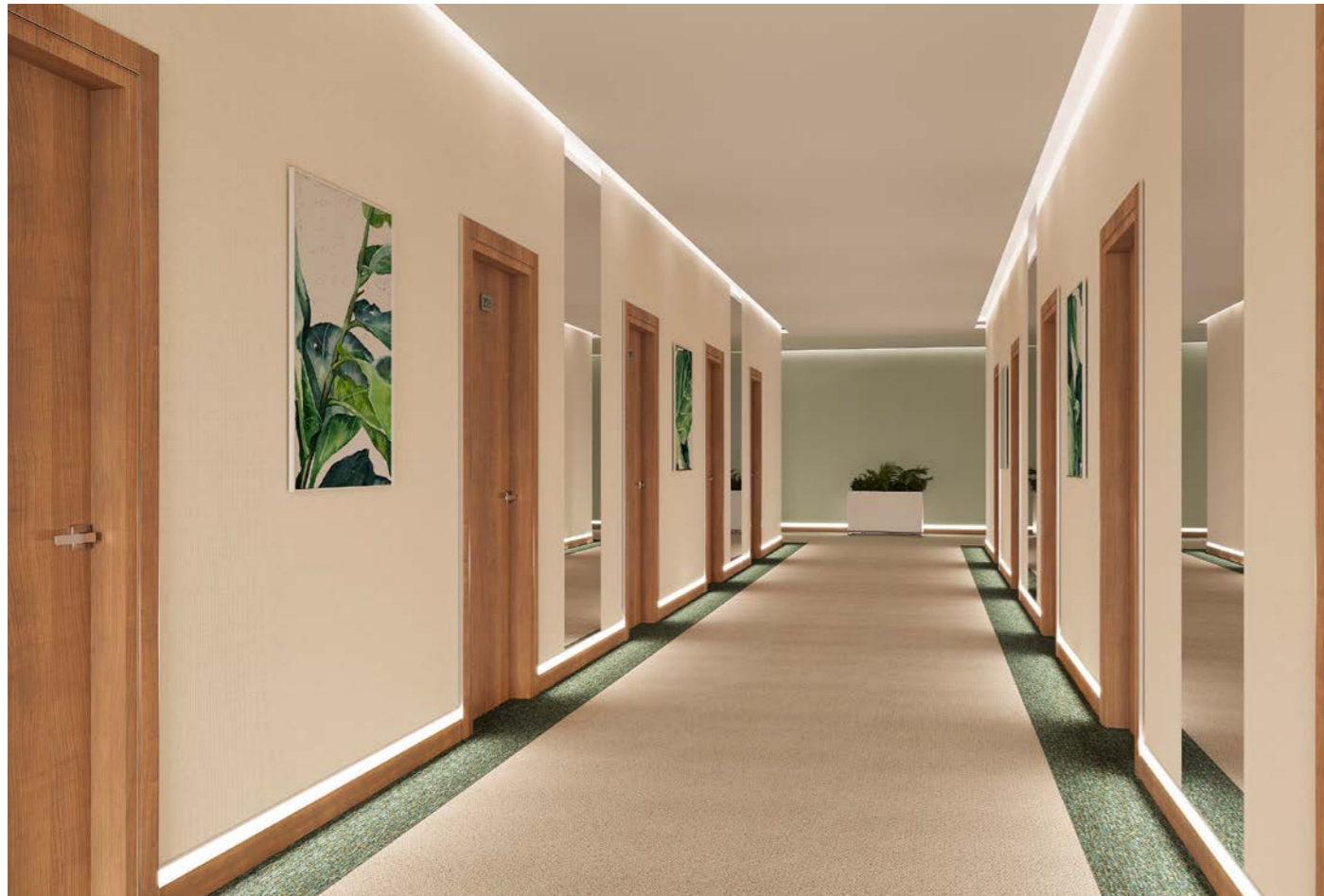

Profil aluminiowy DEOLINE C 2 m, 3 m*
Aluminum profile DEOLINE C 2 m, 3 m**

AL

PROFIL-DEOLINE-C-(2M/3M)-W



Profil architektoniczny DEOLINE C do płyt gipsowo-kartonowych. Przeznaczony do taśm LED o maksymalnej szerokości 10 mm.

Architectural profile DEOLINE C for plasterboard. Designed for LED strips with a maximum width of 10 mm.

Schemat montażu:
Assembly instruction:



OP2-ZASL-DEOLINE-C-SZ-01W



Rysunek techniczny:
Technical drawing:

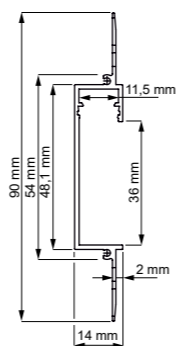

www.designlight.pl



www.designlight.eu



*Tolerancja długości profili i kloszy wynosi +/- 2 mm.
**The tolerance of the length of profiles and diffusers is +/- 2 mm.

Profil aluminiowy DEOLINE J 2 m, 3 m*
Aluminum profile DEOLINE J 2 m, 3 m**

AL

PROFIL-DEOLINE-J-(2M/3M)-W



Profil architektoniczny DEOLINE J do płyt gipsowo-kartonowych. Przeznaczony do taśm LED o maksymalnej szerokości 10 mm.

Architectural profile DEOLINE J for plasterboard. Designed for LED strips with a maximum width of 10 mm.

Schemat montażu:
Assembly instruction:



OP2-ZASL-DEOLINE-J-SZ-01W



Rysunek techniczny:
Technical drawing:

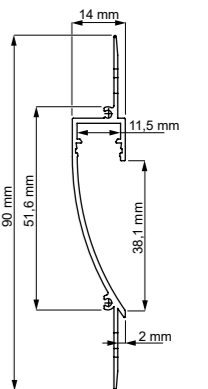

www.designlight.pl



www.designlight.eu



*Tolerancja długości profili i kloszy wynosi +/- 2 mm.
**The tolerance of the length of profiles and diffusers is +/- 2 mm.



Profil aluminiowy CERAMIC LINE K*
Aluminum profile Ceramic Line K 2 and 3m**

AL

PRO-CERLINE-K-AL-OP-(2M/3M)-01



Aluminiowy profil, przeznaczony do montażu pod płytkami ceramicznymi na ścianach, pozwala na stworzenie unikalnych linii światła między płytkami, a ścianą lub inną powierzchnią wystającą np. półką.

The aluminum profile, intended for installation under ceramic tiles on walls, allows you to create unique lines of light between the tiles and the wall or other protruding surface, e.g. a shelf.

Rysunek techniczny:
Technical drawing:

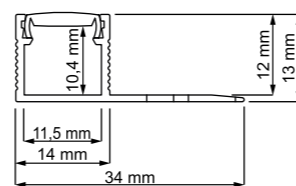

Schemat montażu:
Assembly instruction:

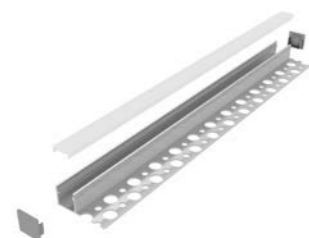

OP2-ZASL-13x14-SZ-02 OP2-ZASL-13x14-SZ-02W



www.designlight.pl



www.designlight.eu



*Tolerancja długości profili i kloszy wynosi +/- 2 mm.
**The tolerance of the length of profiles and diffusers is +/- 2 mm.

Profil aluminiowy CERAMIC LINE P*
Aluminum profile Ceramic Line P 2 and 3m**

AL

PRO-CERLINE-P-AL-OP-(2M/3M)-01



Aluminiowy profil przystosowany do montażu taśm LED o szerokości do 10 mm pod płytkami ceramicznymi do 8 mm grubości.

Aluminum profile suitable for mounting LED strips up to 10 mm wide under ceramic tiles up to 8 mm thick.

Rysunek techniczny:
Technical drawing:

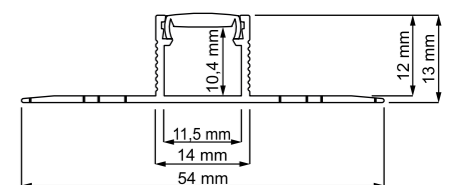

Schemat montażu:
Assembly instruction:



OP2-ZASL-13x14-SZ-02 OP2-ZASL-13x14-SZ-02W



www.designlight.pl



www.designlight.eu



*Tolerancja długości profili i kloszy wynosi +/- 2 mm.
**The tolerance of the length of profiles and diffusers is +/- 2 mm.

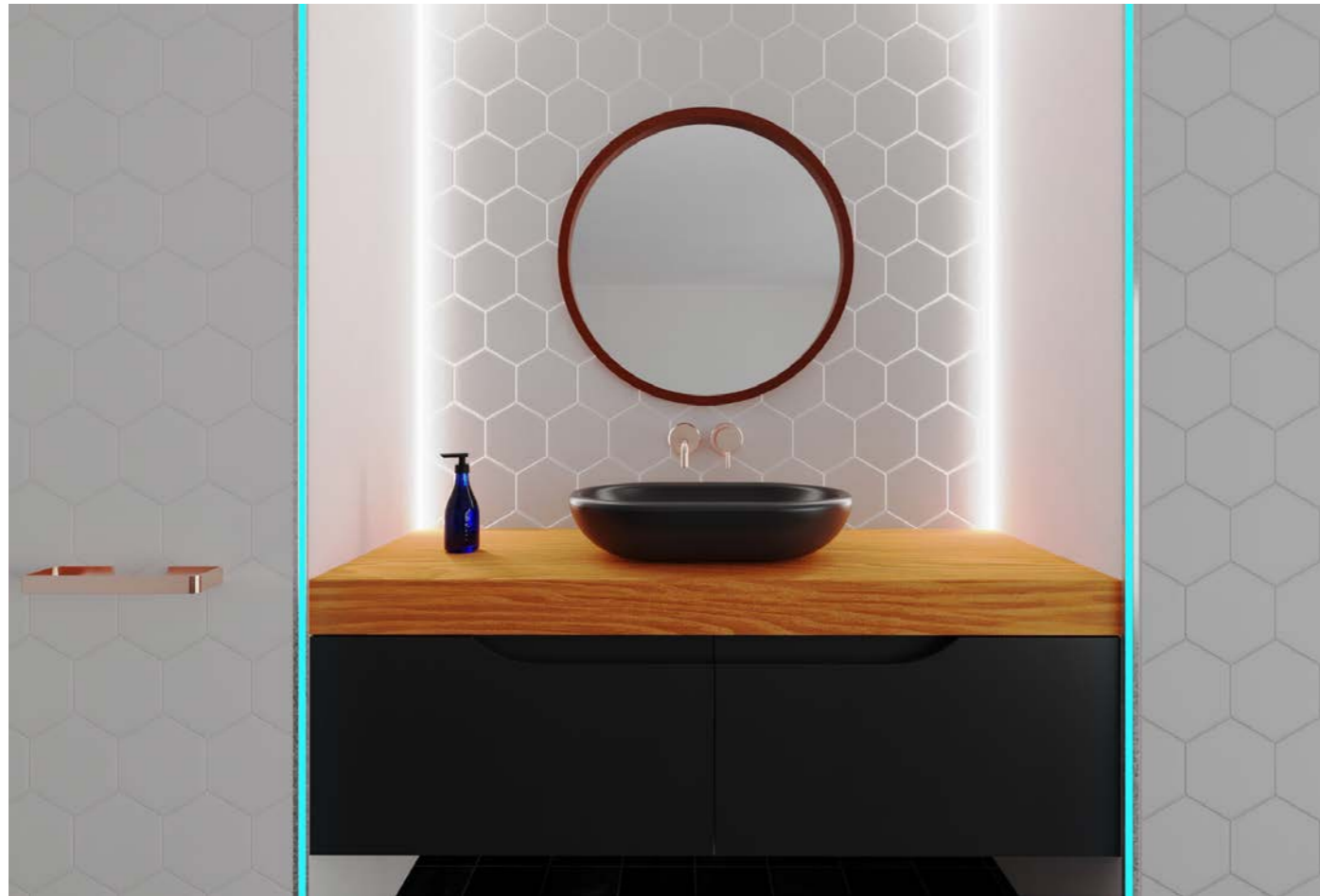

Profil aluminiowy CERAMIC LINE W*
Aluminum profile Ceramic Line W 2 and 3m**

AL

PRO-CERLINE-W-AL-OP-(2M/3M)-01



Aluminiowy profil, przeznaczony do montażu pod płytkami ceramicznymi, w narożnikach zewnętrznych czy dowolnej przestrzeni z ceramiką.

Aluminum profile, intended for installation under ceramic tiles, in external corners or any space with ceramics.

Rysunek techniczny:
Technical drawing:

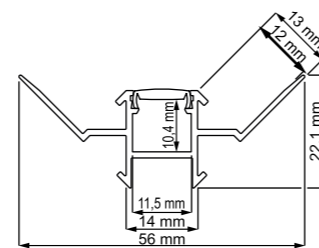

Schemat montażu:
Assembly instruction:



OP2-ZASL-13x14-SZ-02



OP2-ZASL-13x14-SZ-02W



www.designlight.pl



www.designlight.eu



*Tolerancja długości profili i kloszy wynosi +/- 2 mm.
**The tolerance of the length of profiles and diffusers is +/- 2 mm.

Profil aluminiowy CERAMIC LINE Z*
Aluminum profile Ceramic Line Z 2 and 3m**

AL

PRO-CERLINE-Z-AL-OP-(2M/3M)-01



Aluminiowy profil, przeznaczony do montażu pod płytkami ceramicznymi, w narożnikach zewnętrznych czy dowolnej przestrzeni z ceramiką.

Aluminum profile, intended for installation under ceramic tiles, in external corners or any space with ceramics.

Rysunek techniczny:
Technical drawing:

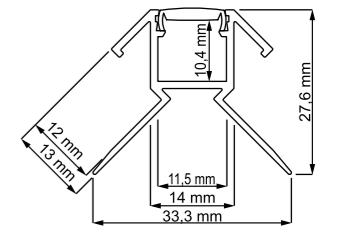

Schemat montażu:
Assembly instruction:

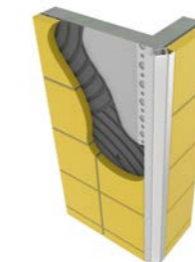
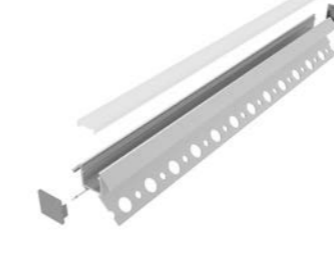

OP2-ZASL-13x14-SZ-02

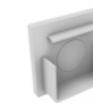

OP2-ZASL-13x14-SZ-02W



www.designlight.pl



www.designlight.eu



*Tolerancja długości profili i kloszy wynosi +/- 2 mm.
**The tolerance of the length of profiles and diffusers is +/- 2 mm.



Profil aluminiowy FOBOS 2 m, 3 m*
Aluminum profile FOBOS 2 m, 3 m**

AL

PROF-FOBOS-AL-OP-(2M/3M)



FOBOS to wpuszczany profil architektoniczny z serii ASTRO przeznaczony do montażu dwóch taśm LED o maksymalnej szerokości 12 mm.

FOBOS is a recessed architectural aluminum profile intended to accommodate two LED strips of maximum width of 12 mm.

Rysunek techniczny:
Technical drawing:

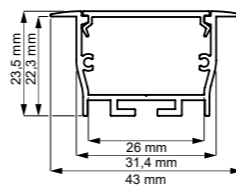

Schemat montażu:
Assembly instruction:



LACZ-AST-90-PZ-SN-01W



LACZ-AST-PZ-SN-01W



OP2-ZASL-FOBOS-SZ-01W



SPR-AST-30-PD-01W



www.designlight.pl



www.designlight.eu



*Tolerancja długości profili i kloszy wynosi +/- 2 mm.
**The tolerance of the length of profiles and diffusers is +/- 2 mm.

Profil aluminiowy FOBOS XL 2 m, 3 m*
Aluminum profile FOBOS XL 2 m, 3 m**

AL

PROF-FOBOSXL-AL-OP-(2M/3M)



FOBOS XL to wpuszczany profil architektoniczny z serii ASTRO przeznaczony do montażu trzech taśm LED o maksymalnej szerokości 12 mm.

FOBOS XL is a recessed architectural aluminum profile intended to accommodate three LED strips of maximum width of 12 mm.

Rysunek techniczny:
Technical drawing:

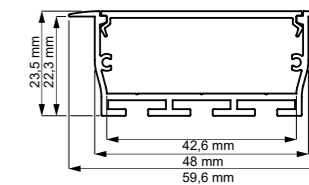

Schemat montażu:
Assembly instruction:



LACZ-AST-90-PZ-SN-01W



LACZ-AST-PZ-SN-01W



OP2-ZASL-FOBOSXL-SZ-01W



SPR-AST-30-PD-01W



www.designlight.pl



www.designlight.eu



*Tolerancja długości profili i kloszy wynosi +/- 2 mm.
**The tolerance of the length of profiles and diffusers is +/- 2 mm.

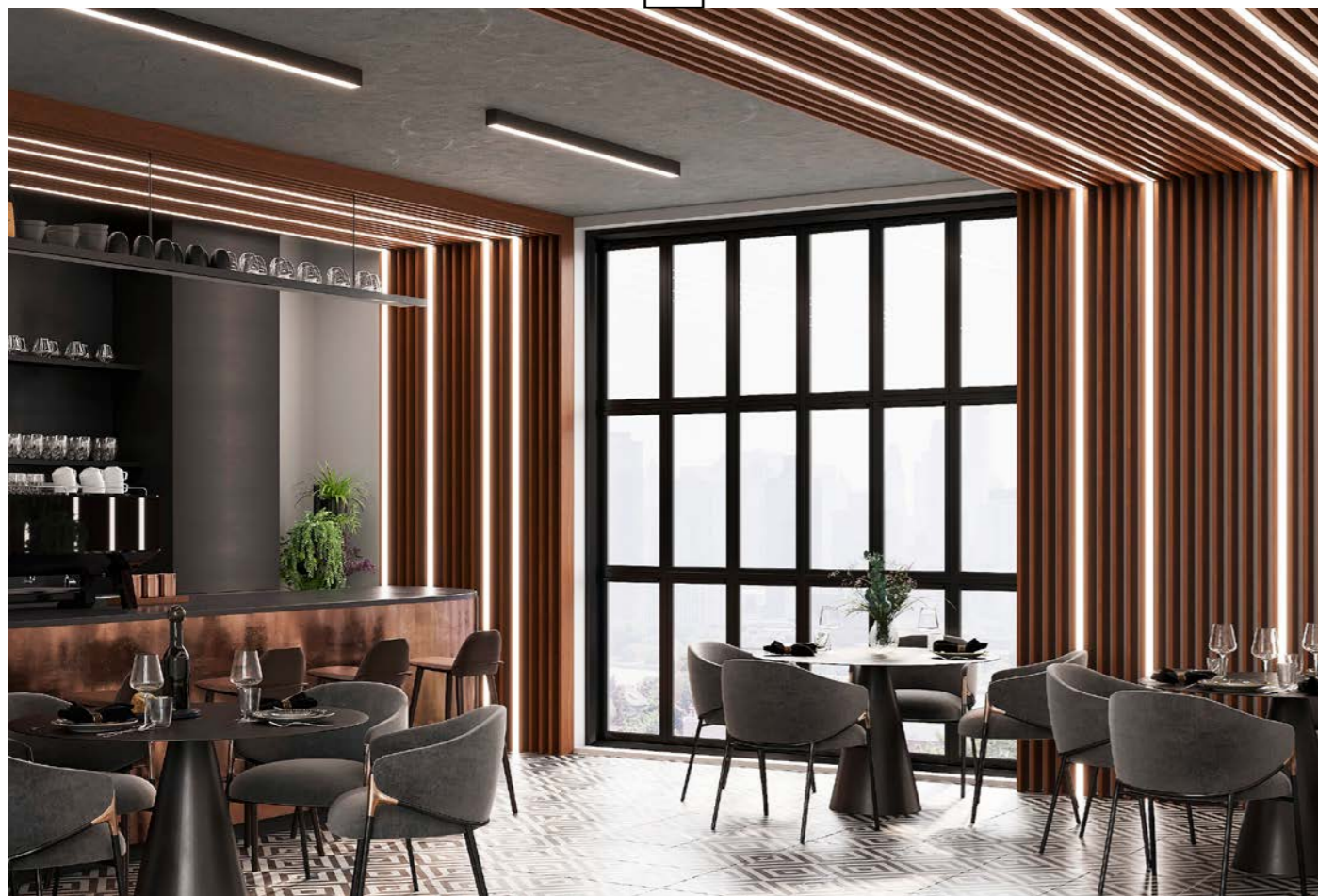

Profil aluminiowy JAPET 2 m, 3 m*
Aluminum profile JAPET 2 m, 3 m**

AL

PROF-JAPET-AL-OP-(2M/3M)



Nawierzchniowy profil aluminiowy JAPET to profil architektoniczny z serii ASTRO przeznaczony do montażu dwóch taśm LED o maksymalnej szerokości 12 mm.

The JAPET aluminium surface profile is an architectural profile from the ASTRO series designed for the installation of two LED strips with a maximum width of 12 mm.

Rysunek techniczny:
Technical drawing:

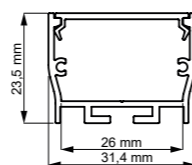

Schemat montażu:
Assembly instruction:



LACZ-AST-90-PZ-SN-01W



LACZ-AST-PZ-SN-01W



OP2-ZASL-JAPET-SZ-01W



www.designlight.pl



www.designlight.eu



*Tolerancja długości profili i kloszy wynosi +/- 2 mm.
**The tolerance of the length of profiles and diffusers is +/- 2 mm.

Profil aluminiowy JAPET XL 2 m, 3 m*
Aluminum profile JAPET XL 2 m, 3 m**

AL

CZ

PROF-JAPETXL-AL-OP-(2M/3M)



PROF-JAPETXL-CZ-OP-3M



Nawierzchniowy profil aluminiowy JAPET XL to profil architektoniczny z serii ASTRO przeznaczony do montażu trzech taśm LED o maksymalnej szerokości 12 mm.

The JAPET XL surface aluminum profile is an architectural profile from the ASTRO series designed for mounting three LED strips with a maximum width of 12 mm.

Rysunek techniczny:
Technical drawing:

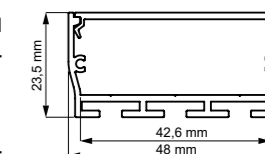

Schemat montażu:
Assembly instruction:



LACZ-AST-90-PZ-SN-01W



LACZ-AST-PZ-SN-01W



OP2-ZASL-JAPETXL-SZ-01W



OP2-ZASL-JAPETXL-CZ-01W



www.designlight.pl



www.designlight.eu



*Tolerancja długości profili i kloszy wynosi +/- 2 mm.
**The tolerance of the length of profiles and diffusers is +/- 2 mm.



Profil aluminiowy NARVI 3 m*
Aluminum profile NARVI 3 m**

AL BI CZ

PROF-NARVI-(AL/BI/CZ)-OP-3M

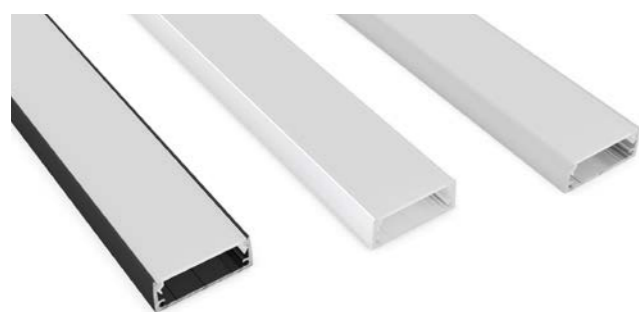

Aluminiowy profil architektoniczny przeznaczony do montażu nawierzchniowego. Profil NARVI pozwala na montaż dwóch taśm LED o maksymalnej szerokości 12 mm.

Aluminum architectural profile intended for installation on surfaces. Profile NARVI is adjusted for two LED strips of 12 mm max width.

Schemat montażu:
Assembly instruction:

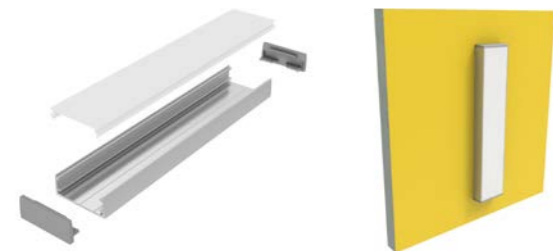

Rysunek techniczny:
Technical drawing:

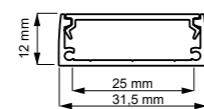

OP2-ZASL-NARVI-SZ-01

OP2-ZASL-NARVI-BI-01

OP2-ZASL-NARVI-CZ-01

www.designlight.pl



www.designlight.eu



* Tolerancja długości profili i kloszy wynosi +/- 2 mm.
** The tolerance of the length of profiles and diffusers is +/- 2 mm.

Lampa liniowa LED BROOKLYN
LED linear lamp BROOKLYN

CZ 4000K **Biała neutralna**
Neutral white

BRK24-1000-40-CZ-OP-01

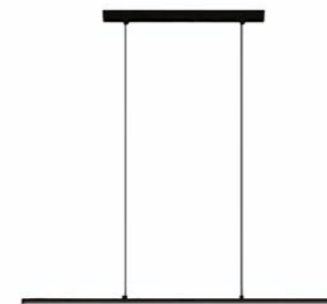

Lampa LED BROOKLYN - idealne oświetlenie blatu roboczego w Twojej w kuchni lub biurze:

- produkt gotowy do podłączenia;
- duży strumień świetlny 3500 lm;
- możliwość regulacji wysokości.

LED lamp BROOKLYN - perfect lighting for your worktop in your kitchen or office:

- product ready for connection;
- high luminous flux of 3500 lm;
- height adjustable.

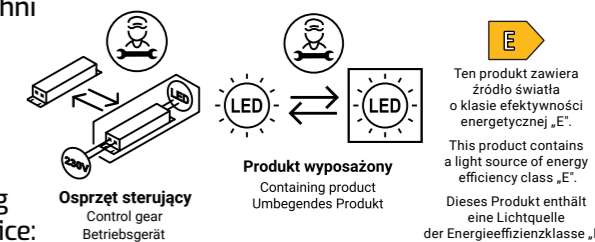

Osprzęt sterujący
Control gear
Betriebsgerät

Produkt wyposażony
Containing product
Umbegabendes Produkt

Ten produkt zawiera źródło światła o klasie efektywności energetycznej „E”.
This product contains a light source of energy efficiency class „E”.
Dieses Produkt enthält eine Lichtquelle der Energieeffizienzklasse „E”.

Dane techniczne:
Technical data:

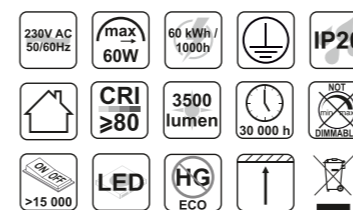

RoHS CE UK CA

Rysunek techniczny:
Technical drawing:

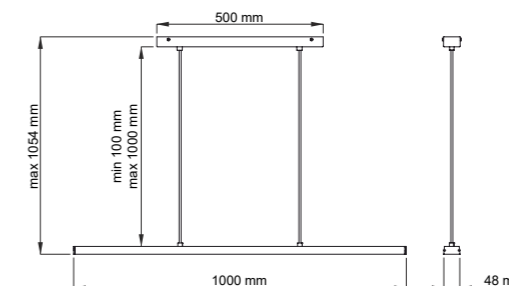

www.designlight.pl



www.designlight.eu



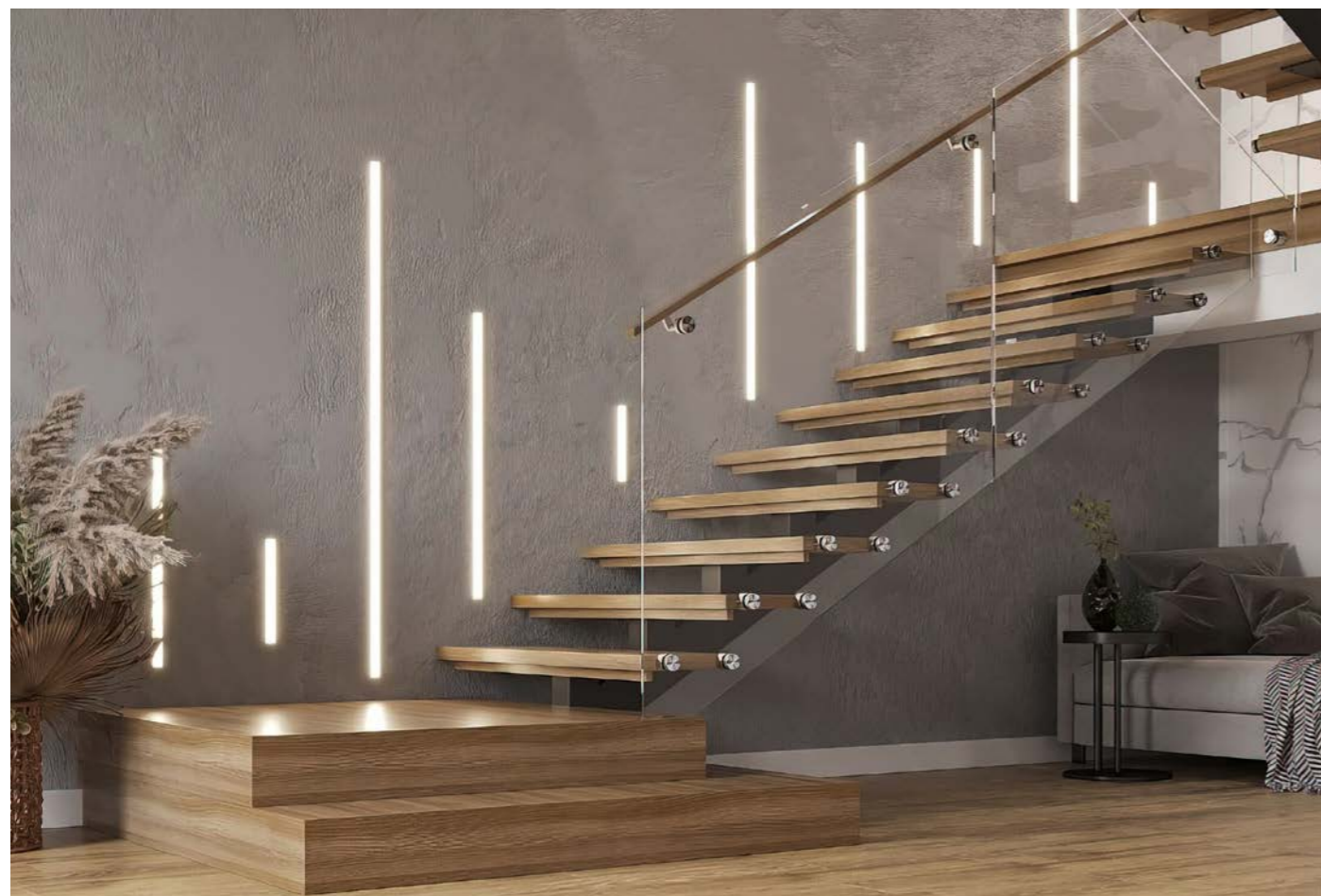

Oświetlenie schodowe LED LUMI FLOW
LED lighting for staircases LUMI FLOW

AL BI CZ

4000K **Biała neutralna**
Neutral white

LUMIF-(długość w mm)-40-1-(kolor oprawy)-01
LUMIF-(length in mm)-40-1-(luminaire color)-01



LUMI FLOW to nowoczesna oprawa schodowa, która zachwyca swoją prostotą i designem. Możliwość zamówienia tej oprawy LED na wymiar, pozwala użytkownikowi na tworzenie indywidualnych instalacji świetlnych.

LUMI FLOW is a modern stair luminaire that impresses with its simplicity and design. Thanks to the possibility of ordering luminaires of various lengths, the user can create individual lighting installations.

Dane techniczne:

Technical data:

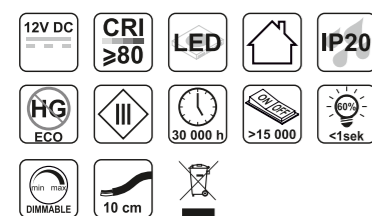

RoHS CE UK CA

Rysunek techniczny:

Technical drawing:

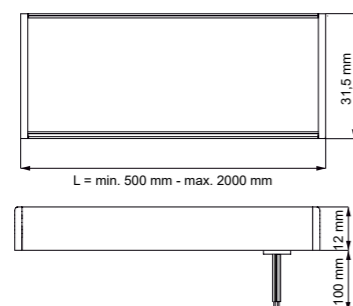

20

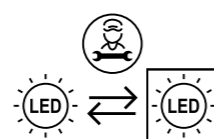

Produkt wyposażony
Containing product
Umbegabendes Produkt

Ten produkt zawiera źródło światła o klasie efektywności energetycznej „F”.
This product contains a light source of energy efficiency class „F”.
Dieses Produkt enthält eine Lichtquelle der Energieeffizienzklasse „F”.

www.designlight.pl



www.designlight.eu



3000K **Biała ciepła**
Warm white

4000K **Biała neutralna**
Neutral white

6000K **Biała zimna**
Cool white

Indeks Index	Taśma 24V DC 60 LED/m, 11W/m LED strip 24V DC, 60 LED/m, 11W/m	Długość rolki Roll length
R-24-2835-50-20-30K-05	TAŚMA PREMIUM 24V DC, Made in Poland , dł. 50 m, 2835 IP20, 60 LED/m, szer 8 mm, 6 pkt/10 cm, b. ciepła, moc 11W/m. LED strip PREMIUM 24V DC, Made in Poland , length 50 m, 2835 IP20, 60 LED/m, width 8 mm, 6 pkt/10 cm, warm white, power 11W/m.	50 m
R-24-2835-50-20-40K-05	TAŚMA PREMIUM 24V DC, Made in Poland , dł. 50 m, 2835 IP20, 60 LED/m, szer 8 mm, 6 pkt/10 cm, b. neutralna, moc 11W/m. LED strip PREMIUM 24V DC, Made in Poland , length 50 m, 2835 IP20, 60 LED/m, width 8 mm, 6 pkt/10 cm, neutral white, power 11W/m.	50 m
R-24-2835-50-20-60K-05	TAŚMA PREMIUM 24V DC, Made in Poland , dł. 50 m, 2835 IP20, 60 LED/m, szer 8 mm, 6 pkt/10 cm, b. zimna, moc 11W/m. LED strip PREMIUM 24V DC, Made in Poland , length 50 m, 2835 IP20, 60 LED/m, width 8 mm, 6 pkt/10 cm, cool white, power 11W/m.	50 m
R-24-2835-5-20-30K-05	TAŚMA PREMIUM 24V DC, Made in Poland , dł. 5 m, 2835 IP20, 60 LED/m, szer 8 mm, 6 pkt/10 cm, b. ciepła, moc 11W/m. LED strip PREMIUM 24V DC, Made in Poland , length 5 m, 2835 IP20, 60 LED/m, width 8 mm, 6 pkt/10 cm, warm white, power 11W/m.	5 m
R-24-2835-5-20-40K-05	TAŚMA PREMIUM 24V DC, Made in Poland , dł. 5 m, 2835 IP20, 60 LED/m, szer 8 mm, 6 pkt/10 cm, b. neutralna, moc 11W/m. LED strip PREMIUM 24V DC, Made in Poland , length 5 m, 2835 IP20, 60 LED/m, width 8 mm, 6 pkt/10 cm, neutral white, power 11W/m.	5 m
R-24-2835-5-20-60K-05	TAŚMA PREMIUM 24V DC, Made in Poland , dł. 5 m, 2835 IP20, 60 LED/m, szer 8 mm, 6 pkt/10 cm, b. zimna, moc 11W/m. LED strip PREMIUM 24V DC, Made in Poland , length 5 m, 2835 IP20, 60 LED/m, width 8 mm, 6 pkt/10 cm, cool white, power 11W/m.	5 m

Indeks Index	Taśma 24V DC 120 LED/m, 19W/m LED strip 24V DC, 120 LED/m, 19W/m	Długość rolki Roll length
R-24-2835-50-20-30K-04	TAŚMA PREMIUM 24V DC, Made in Poland , dł. 50 m, 2835 IP20, 120 LED/m, szer 8 mm, 6 pkt/5 cm, b. ciepła, moc 19W/m. LED strip PREMIUM 24V DC, Made in Poland , length 50 m, 2835 IP20, 120 LED/m, width 8 mm, 6 pkt/5 cm, warm white, power 19W/m.	50 m
R-24-2835-50-20-40K-04	TAŚMA PREMIUM 24V DC, Made in Poland , dł. 50 m, 2835 IP20, 120 LED/m, szer 8 mm, 6 pkt/5 cm, b. neutralna, moc 19W/m. LED strip PREMIUM 24V DC, Made in Poland , length 50 m, 2835 IP20, 120 LED/m, width 8 mm, 6 pkt/5 cm, neutral white, power 19W/m.	50 m
R-24-2835-50-20-60K-04	TAŚMA PREMIUM 24V DC, Made in Poland , dł. 50 m, 2835 IP20, 120 LED/m, szer 8 mm, 6 pkt/5 cm, b. zimna, moc 19W/m. LED strip PREMIUM 24V DC, Made in Poland , length 50 m, 2835 IP20, 120 LED/m, width 8 mm, 6 pkt/5 cm, cool white, power 19W/m.	50 m
R-24-2835-5-20-30K-04	TAŚMA PREMIUM 24V DC, Made in Poland , dł. 5 m, 2835 IP20, 120 LED/m, szer 8 mm, 6 pkt/5 cm, b. ciepła, moc 19W/m. LED strip PREMIUM 24V DC, Made in Poland , length 5 m, 2835 IP20, 120 LED/m, width 8 mm, 6 pkt/5 cm, warm white, power 19W/m.	5 m
R-24-2835-5-20-40K-04	TAŚMA PREMIUM 24V DC, Made in Poland , dł. 5 m, 2835 IP20, 120 LED/m, szer 8 mm, 6 pkt/5 cm, b. neutralna, moc 19W/m. LED strip PREMIUM 24V DC, Made in Poland , length 5 m, 2835 IP20, 120 LED/m, width 8 mm, 6 pkt/5 cm, neutral white, power 19W/m.	5 m
R-24-2835-5-20-60K-04	TAŚMA PREMIUM 24V DC, Made in Poland , dł. 5 m, 2835 IP20, 120 LED/m, szer 8 mm, 6 pkt/5 cm, b. zimna, moc 19W/m. LED strip PREMIUM 24V DC, Made in Poland , length 5 m, 2835 IP20, 120 LED/m, width 8 mm, 6 pkt/5 cm, cool white, power 19W/m.	5 m

Taśmy LED dostępne są także w opcji 12V DC.
LED strips are also available in a 12V DC version.

	Indeks Index	Zasilacz LED 24V DC LED power supply 24V DC	T max (°C)	L (mm)	H (mm)	W (mm)
	TRA-24-S-150W-02	ZASILACZ LED PREMIUM 24V DC 150W POWER SUPPLY LED PREMIUM 24V DC 150W	80	180	31	65
	TRA-24-SL-75W-T-02	ZASILACZ LED PREMIUM 24V DC 75W SLIM LONG POWER SUPPLY LED PREMIUM 24V DC 75W SLIM LONG	90	305	17	30
	TRA-24-SL-150W-T-02	ZASILACZ LED PREMIUM 24V DC 150W SLIM LONG POWER SUPPLY LED PREMIUM 24V DC 150W SLIM LONG	80	321	18,5	30
	TRA-24-SP-33W-02	ZASILACZ LED STANDARD PLUS 24V DC 33W POWER SUPPLY LED STANDARD PLUS 24V DC 33W	85	140	25	47
	TRA-24-SP-54W-02	ZASILACZ LED STANDARD PLUS 24V DC 54W POWER SUPPLY LED STANDARD PLUS 24V DC 54W	85	152	32	59
	TRA-24-SP-65W-02	ZASILACZ LED STANDARD PLUS 24V DC 65W POWER SUPPLY LED STANDARD PLUS 24V DC 65W	80	152	32	59
	TRA-24-SP-80W-02	ZASILACZ LED STANDARD PLUS 24V DC 80W POWER SUPPLY LED STANDARD PLUS 24V DC 80W	85	156	35	63
	TRA-24-F-36W-T-03	ZASILACZ LED FLAT 24V DC 36W POWER SUPPLY LED STANDARD PLUS 24V DC 36W	80	145	18	52
	TRA-24-F-60W-T-03	ZASILACZ LED FLAT 24V DC 60W POWER SUPPLY LED STANDARD PLUS 24V DC 60W	85	179	18	61

Zasilacze LED dostępne są także w opcji 12V DC.
LED power supplies are also available in a 12V DC version.

		Indeks Index	Sterownik i pilot RF 12-24V DC Controller and remote RF 12-24V DC	Wymiary sterownika Controller dimensions		
				L (mm)	H (mm)	W (mm)
		MULTI-STER-BI-01 MULTI-N-PILOT-BI-01	STEROWNIK RF MULTI 5W1 PILOT NAŚCIENNY RF 4 STEFOWY MULTI 5W1 RF CONTROLLER MULTI 5IN1 RF REMOTE CONTROL MULTI 5IN1 4 ZONES SURFACE MOUNTED	122	22	38
		MULTI-STER-BI-01 MULTI-PILOT-BI-01	STEROWNIK RF MULTI 5W1 PILOT RF 4 STEFOWY MULTI 5W1 RF CONTROLLER MULTI 5IN1 RF REMOTE CONTROL MULTI 5IN1 4 ZONES	122	22	38
		SELI-Z-1P-RF-10A-01 SELI-Z-1P-RF-10A-CZ-01	ZESTAW SELI - STEROWNIK MONO RF Z PILOTEM SELI SET - RF CONTROLLER MONO WITH RF REMOTE CONTROL	85	22	45
		STER-MONO-RF-10A-01 STER-MON-RF-PILOT-01	STEROWNIK RF MONO PILOT RF 4 STREFOWY MONO/BICOLOR RF CONTROLLER MONO RF REMOTE CONTROL 4 ZONES MONO/BICOLOR	85	22	45
		STER-BK-RF-10A-01 STER-MON-RF-PILOT-01	STEROWNIK RF BICOLOR PILOT RF 4 STEFOWY MONO/BICOLOR RF CONTROLLER BICOLOR RF REMOTE CONTROL 4 ZONES MONO/BICOLOR	85	22	45
		STER-RGB-RF-10A-01 STER-RGB-RF-PILOT-01	STEROWNIK RF RGB PILOT RF 4 STREFOWY RGB I RGBW RF CONTROLLER RGB RF REMOTE CONTROL 4 ZONES RGB AND RGBW	85	22	45
		STER-RGBW-RF-10A-01 STER-RGB-RF-PILOT-01	STEROWNIK RF RGBW PILOT RF 4 STREFOWY RGB I RGBW RF CONTROLLER RGBW RF REMOTE CONTROL 4 ZONES RGB AND RGBW	85	22	45

Niniejszy katalog nie stanowi oferty w rozumieniu prawnym i jest publikowany jedynie w celach informacyjnych!
Design Light Sp. z o.o. zastrzega sobie prawo do zmiany oferty katalogowej.
Design Light Sp. z o.o. zastrzega sobie prawo do zmian technicznych i technicznej charakterystyki prezentowanych produktów.
Aktualne informacje na stronie internetowej lub w biurze handlowym.
Wszystkie produkty z tego katalogu są zgodne z CE i RoHS.

Pracownicy naszej firmy dołożyli wszelkich możliwych starań, aby prezentowane w katalogu informacje były prawdziwe i aktualne, jednak nie mogą tego zagwarantować.
Dlatego błędne informacje nie mogą być podstawą do roszczeń.
W przypadku jakichkolwiek wątpliwości prosimy przed podjęciem decyzji o kontakt z pracownikiem firmy.

This catalogue does not constitute an offer in the legal sense and is published for information purposes only!
Design Light Sp. z o.o. reserves the right to change the catalogue offer.
Design Light Sp. z o.o. reserves the right to technical changes and characteristics of the presented products.
Visit the website or contact the sales office for up-to-date information.
All products in this catalogue remain in accordance with CE and RoHS standards.

Design Light team has done its best to ensure that information presented in this catalogue is correct and up-to-date but we can't guarantee that, so information included in the catalog cannot be used as a basis for claims.
If you have any doubts, please feel free contact Design Light before making a decision.

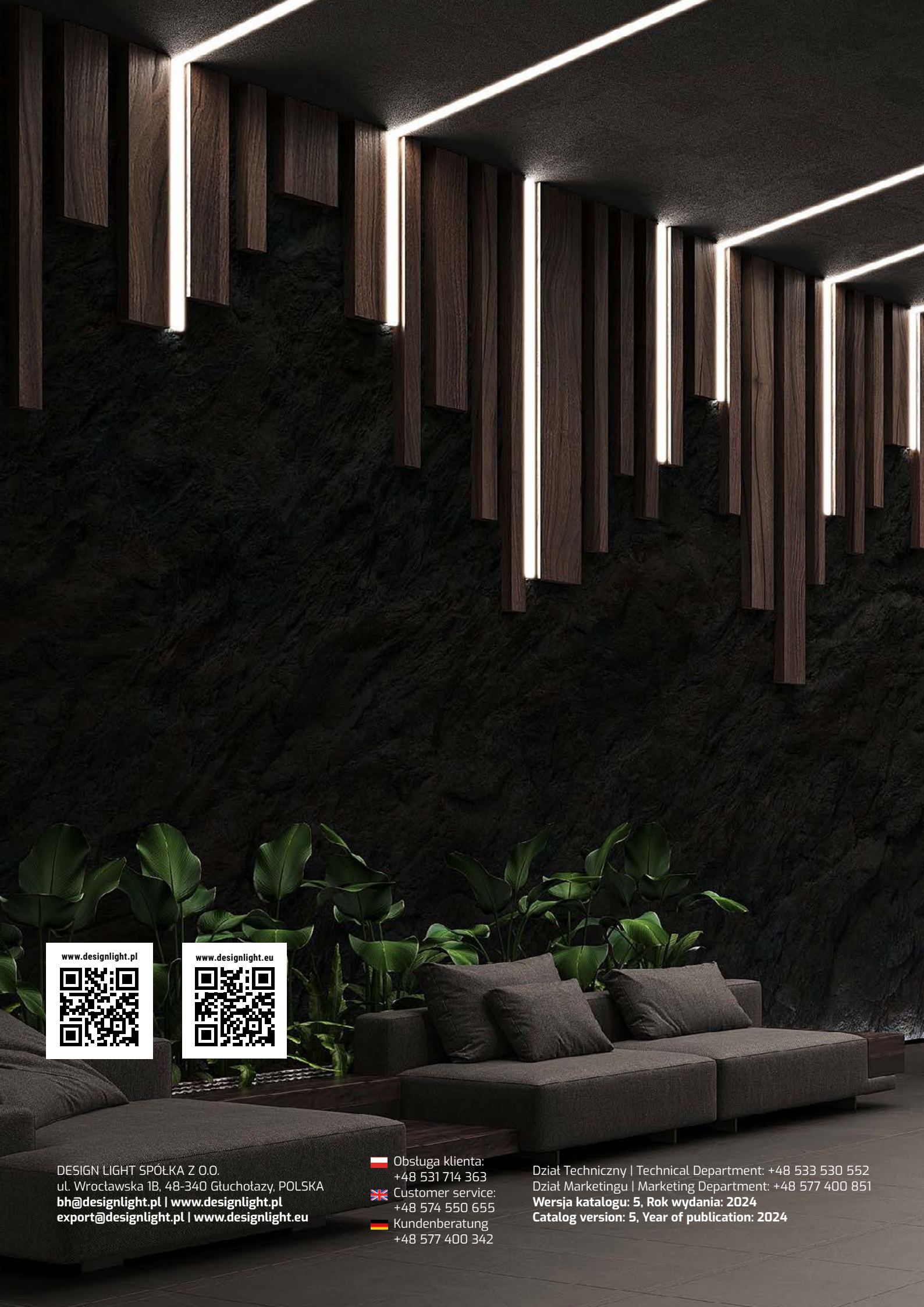



www.designlight.pl



www.designlight.eu



DESIGN LIGHT SPÓŁKA Z O.O.
ul. Wrocławska 1B, 48-340 Głuchołazy, POLSKA
bh@designlight.pl | www.designlight.pl
export@designlight.pl | www.designlight.eu

 Obsługa klienta:
+48 531 714 363
 Customer service:
+48 574 550 655
 Kundenberatung
+48 577 400 342

Dział Techniczny | Technical Department: +48 533 530 552
Dział Marketingu | Marketing Department: +48 577 400 851
Wersja katalogu: 5, Rok wydania: 2024
Catalog version: 5, Year of publication: 2024