





Jako firma produkcyjno-handlowa posiadamy wieloletnie doświadczenie. Specjalizujemy się w produkcji oraz sprzedaży zaawansowanych systemów LED do mebli i mieszkań. W naszym bogatym asortymencie znajdują Państwo wszystko to, co niezbędne, aby rozświetlić dom w efektywny, ale również energooszczędny sposób.

Zaopatrujemy największe hurtownie akcesoriów meblowych w Polsce oraz za granicą w nowoczesne i ekologiczne oświetlenie LED. Posiadamy odpowiednie zaplecze techniczne dzięki, któremu jesteśmy w stanie produkować własne oświetlenie i akcesoria takie jak: profile, oprawy LED, płytki SMD oraz inteligentne wyłączniki LED.

Dysponujemy obszernym i nowoczesnym magazynem oraz halą produkcyjną o łącznej powierzchni około 3000 m² oraz 3500 miejsc paletowych. Dzięki komputeryzacji procesów magazynowych jesteśmy w stanie szybko reagować. Każdą wysyłkę traktujemy priorytetowo, ponieważ satysfakcja klienta jest wyznacznikiem jakości naszej pracy. Oferujemy doradztwo, pomoc techniczną oraz fachową obsługę przed i po-sprzedażową. Satysfakcja naszych partnerów jest źródłem inspiracji. Stanowi wskazówkę dla naszych obecnych i przyszłych działań.

Design Light – kreujemy jasną przyszłość wewnątrz.

As a manufacturing and trading company we have many years of experience. We specialize in the production and sale of advanced LED lighting systems for furniture and apartments. In our wide assortment you will find everything what is necessary to illuminate the house in an effective, but still energy-efficient way. We supply the largest furniture accessories wholesalers in Poland and abroad in modern and environmentally friendly LED lighting. Design Light has proper technical facilities through which we are able to produce our own lighting and accessories such as profiles, LED luminaires, SMD plates and intelligent LED switches. Our warehouse and production hall is spacious and modern as it offers storage capacity of 3000 m² and 3500 pallet places. Thanks to the computerization of warehouse processes we are able to respond quickly. We treat each consignment priority, because customer satisfaction is a determinant of our quality of work. We offer consulting, technical assistance and professional service before and after-sales. The satisfaction of our partners is a source of inspiration. It provides guidance for our present and future action.

Design Light – we create a bright future for interiors design.

Als Produktions- und Handelsunternehmen verfügen wir über langjährige Erfahrung. Wir sind auf die Produktion und den Vertrieb von modernen LED-Systemen für Möbel und Wohnungen spezialisiert. In unserem umfangreichen Sortiment finden Sie alles was Sie zum effektiven Beleuchten Ihres Hauses benötigen, dazu energiesparend. Wir beliefern die größten Großhändler für Möbelzubehör in Polen und im Ausland in moderne und umweltfreundliche LED-Beleuchtung. Durch unsere technische Abteilung sind wir in der Lage eigene Beleuchtung und Zubehör herzustellen z.B. Profile, LED Leuchten, SMD Platten und intelligente LED Schalter. Wir verfügen über eine geräumige und moderne Lager- und Produktionshalle mit einer Gesamtfläche von ca. 3000 m² und 3500 Palettenstellplätzen. Mit der Computerisierung der meisten Lagerprozesse, sind wir in der Lage schnell zu reagieren. Jede Sendung wird mit absoluter Priorität behandelt, denn Kundenzufriedenheit bestimmt die Qualität unserer Arbeit. Wir bieten Beratung, technische Unterstützung und professionellen Service vor- und nach dem Einkauf. Die Zufriedenheit unserer Partner ist eine Quelle der Inspiration. Dies gibt Hinweise für unsere jetzigen und zukünftigen Handlungen.

Design Light – Wir schaffen eine strahlende Zukunft für Innenräume.



www.designlight.pl

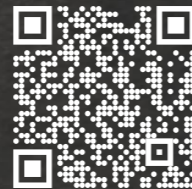

www.designlight.eu

1. Oprawy LED LED luminaires LED Leuchten	4-21
2. Klipsy LED LED clips LED Clips.....	22-25
3. Taśmy LED LED strips LED Streifen.....	26-45
4. Akcesoria do LED LED accessories LED Zubehör.....	46-51
5. Profile do taśm LED LED profiles Profile für LED Streifen.....	52-65
6. Oprawy sufitowe Ceiling luminaires Deckenleuchten.....	66-69
7. Zasilacze LED LED drivers LED Netzteile.....	70-83
8. Sterowniki LED LED controllers LED Controller.....	84-93
9. Wyłączniki LED LED switches LED Schalter.....	94-105
10. Przewody - źródła światła Cables - light sources Kabel - Lichtquellen.....	106-109
11. Przedłużacze - gniazda Extension power socket Steckdosen.....	110-123
12. Czujniki ruchu i zmierzchu Motion and dusk sensors Bewegungsund Dämmerungssensoren.....	124-127
13. Notatki Notes Notizen.....	128
14. Legenda Legend Legende	129-131



OPRAWY LED

LED LUMINAIRES
LED LEUCHTEN



1. IVO 230V AC

Indeks | Index | Index: IVO-SD-()-01



Parametry źródła światła | Light source parameters | Parameter der Lichtquelleto:

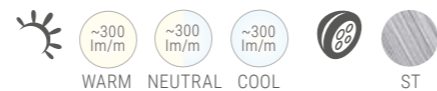

2. SQUARE 2

Indeks | Index | Index: SQUARE2-()-01W

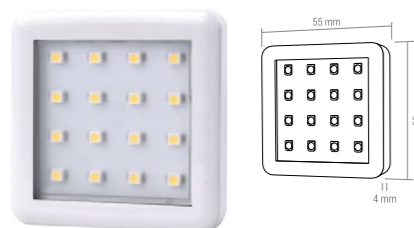

Parametry źródła światła | Light source parameters | Parameter der Lichtquelleto:

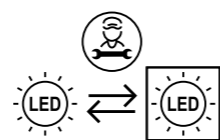

Produkt wyposażony
Containing product
Umbegendes Produkt

Ten produkt zawiera źródło światła o klasie efektywności energetycznej „F”.
This product contains a light source of energy efficiency class „F”.
Dieses Produkt enthält eine Lichtquelle der Energieeffizienzklasse „F”.



3. SQUARE 3

Indeks | Index | Index: SQUARE3-()-01W

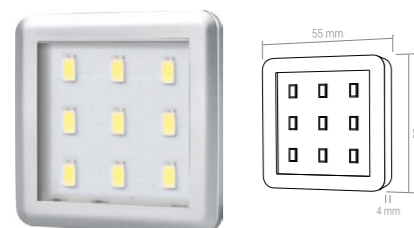

PREMIUM

Parametry źródła światła | Light source parameters | Parameter der Lichtquelleto:

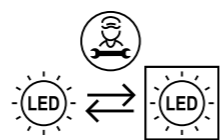

Produkt wyposażony
Containing product
Umbegendes Produkt

Ten produkt zawiera źródło światła o klasie efektywności energetycznej „F”.
This product contains a light source of energy efficiency class „F”.
Dieses Produkt enthält eine Lichtquelle der Energieeffizienzklasse „F”.



4. SQUARE RGB

Indeks | Index | Index: SQUARE2-AL-RGB-01W

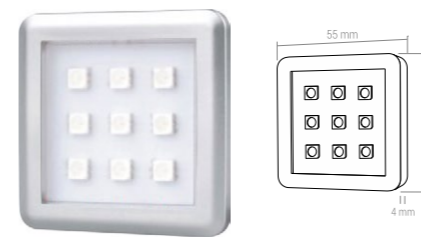

Parametry źródła światła | Light source parameters | Parameter der Lichtquelleto:



5. SQUARE 2 ZESTAW 3 PKT | SQUARE 2 3-PTS SET | SQUARE 2 3ER SET

Indeks | Index | Index: ZSQUARE-3P-()-02W



Możliwość rozbudowy zestawu do 6 pkt.
Option of extending the set up to 6 pts.
Das Set ist erweiterbar auf bis zu 6 Leuchten.

Parametry źródła światła | Light source parameters | Parameter der Lichtquelleto:

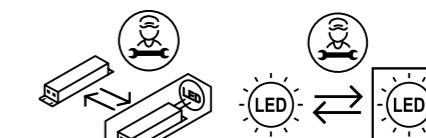

Osprzęt sterujący
Control gear
Betriebsgerät

Produkt wyposażony
Containing product
Umbegendes Produkt

Ten produkt zawiera źródło światła o klasie efektywności energetycznej „F”.
This product contains a light source of energy efficiency class „F”.
Dieses Produkt enthält eine Lichtquelle der Energieeffizienzklasse „F”.



6. SQUARE 3 ZESTAW 3 PKT | SQUARE 3 3-PTS SET | SQUARE 3 3ER SET

Indeks | Index | Index: ZSQUARE3-()-()-02

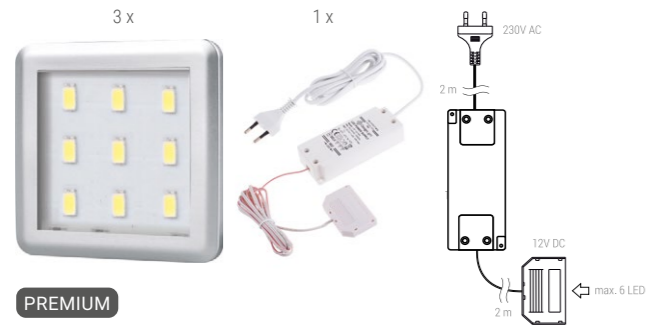

Możliwość rozbudowy zestawu do 6 pkt.
Option of extending the set up to 6 pts.
Das Set ist erweiterbar auf bis zu 6 Leuchten.

Parametry źródła światła | Light source parameters | Parameter der Lichtquelleto:

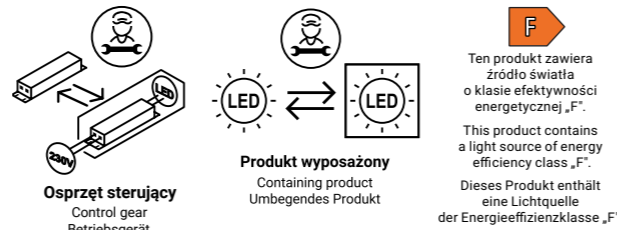

7. SQUARE RGB ZESTAW 3 PKT | SQUARE RGB 3-PTS SET | SQUARE RGB 3ER SET

Indeks | Index | Index: ZSQUARE2-RGB-3P-01W



Możliwość rozbudowy zestawu do 9 pkt.
Option of extending the set up to 9 pts.
Das Set ist erweiterbar auf bis zu 9 Leuchten.

Parametry źródła światła | Light source parameters | Parameter der Lichtquelleto:

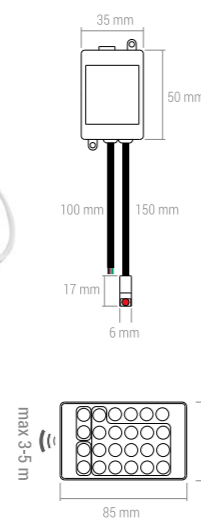

8. FOTON

Indeks | Index | Index: FOTON-()-()-01

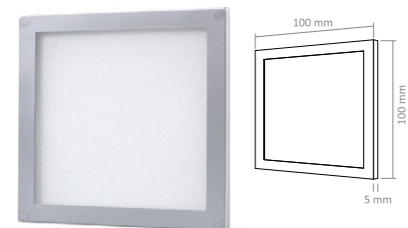

Zeskanuj kod smartfonem i zobacz film jak to działa.
Scan QR code with a smartphone and watch a video of how it works.
Scannen Sie den Code QR mit Ihrem Smartphone und sehen Sie sich das Video an, wie es funktioniert.

Parametry źródła światła | Light source parameters | Parameter der Lichtquelleto:

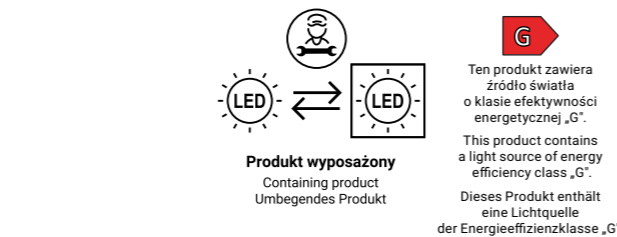

9. FOTON ZESTAW 3 PKT | FOTON 3-PTS SET | FOTON 3ER SET

Indeks | Index | Index: ZFOTON-()-3P-()-01W



Możliwość rozbudowy zestawu do 6 pkt.
Option of extending the set up to 6 pts.
Das Set ist erweiterbar auf bis zu 6 Leuchten.

Parametry źródła światła | Light source parameters | Parameter der Lichtquelleto:

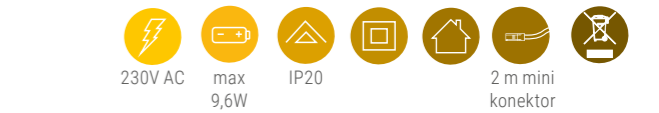
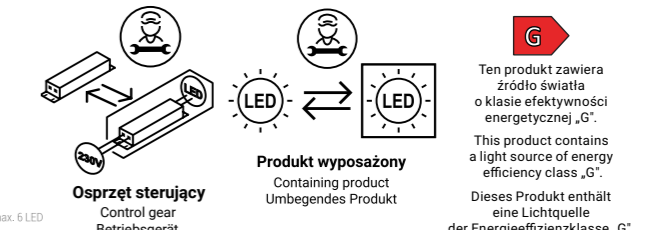
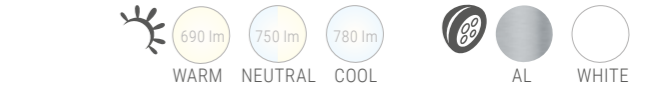

10. OVAL

Indeks | Index | Index: OVAL-2W-()-()-01



Oprawę można zamontować w otworze o średnicy od 55 do 60 mm.
The luminaire can be mounted in a hole with a diameter of 55 to 60 mm.
Die Leuchte kann in einem Einbauloch mit einem Durchmesser von 55 bis 60 mm montiert werden.

Parametry źródła światła | Light source parameters | Parameter der Lichtquelleto:

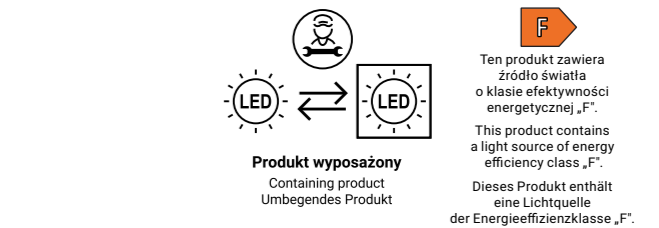

11. OVAL DYSTANS | OVAL WITH DISTANCE | OVAL LED-AUFBAULEUCHE

Indeks | Index | Index: OVAL-2W-()-DY-()-01



Możliwość rozbudowy zestawu do 6 pkt.
Option of extending the set up to 6 pts.
Das Set ist erweiterbar auf bis zu 6 Leuchten.

Parametry źródła światła | Light source parameters | Parameter der Lichtquelleto:

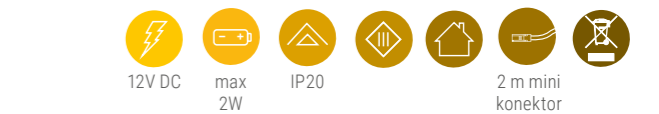
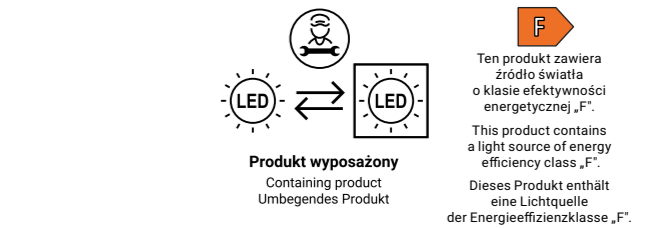



12. OVAL ZESTAW 3 PKT | OVAL 3-PTS SET | OVAL 3ER SET

Indeks | Index | Index: ZOVAL-3P-()-()-V02W

Parametry źródła światła | Light source parameters | Parameter der Lichtquelleto:

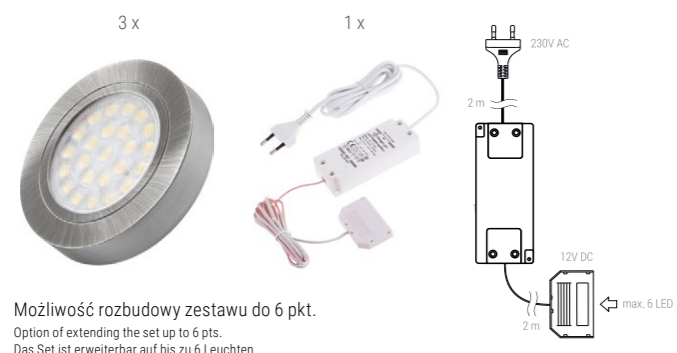
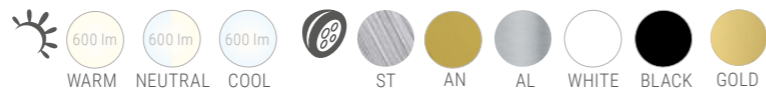

Osprzęt sterujący
Control gear
Betriebsgerät

Produkt wyposażony
Containing product
Umgebendes Produkt

Ten produkt zawiera źródło światła o klasie efektywności energetycznej „F”.
This product contains a light source of energy efficiency class „F”.
Dieses Produkt enthält eine Lichtquelle der Energieeffizienzklasse „F”.

230V AC max 6W IP20 2 m mini konektor euro

13. OVAL SKOS | OVAL SLANT | OVAL SCHRÄG

Indeks | Index | Index: OVAL-2W-SD-SK-()-01

Parametry źródła światła | Light source parameters | Parameter der Lichtquelleto:

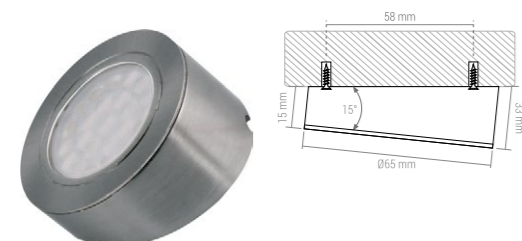

Produkt wyposażony
Containing product
Umgebendes Produkt

Ten produkt zawiera źródło światła o klasie efektywności energetycznej „F”.
This product contains a light source of energy efficiency class „F”.
Dieses Produkt enthält eine Lichtquelle der Energieeffizienzklasse „F”.

12V DC max 2W IP20 2 m mini konektor

14. OVAL SKOS MASTER | OVAL SLANT WITH TOUCH SWITCH | OVAL SCHRÄG MIT BERÜHRUNGSSCHALTER

Indeks | Index | Index: OVAL-2W-SD-SK-()-1M



Master steruje oświetleniem LED podłączonym do rozdzielacza.
Wystarczy jeden dotyk wyłącznika aby włączyć/wyłączyć cały układ LED.
Master controls the LED lighting which is connected to it. Just a single touch of the luminaire, to turn on/off the LED lights.
Master steuert die mit ihr verbundenen LED Leuchten. Es reicht eine Berührung um das ganze LED System EIN/AUS zu schalten.

Parametry źródła światła | Light source parameters | Parameter der Lichtquelleto:



Produkt wyposażony
Containing product
Umgebendes Produkt

Ten produkt zawiera źródło światła o klasie efektywności energetycznej „F”.
This product contains a light source of energy efficiency class „F”.
Dieses Produkt enthält eine Lichtquelle der Energieeffizienzklasse „F”.

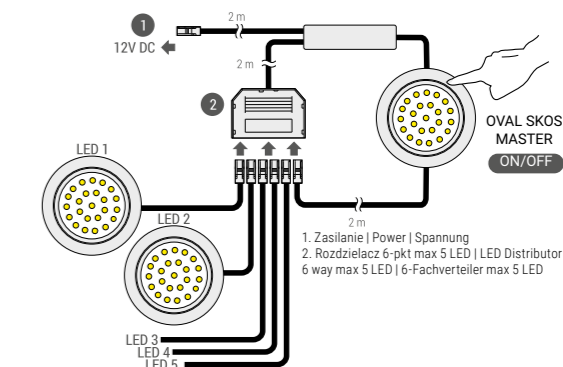

Zeskanuj kod smartfonem i zobacz film jak to działa.
Scan QR code with a smartphone and watch a video of how it works.
Scannen Sie den Code QR mit Ihrem Smartphone und sehen Sie sich das Video an, wie es funktioniert.

Uniwersalność: Do oprawy MASTER można również podłączać inne oprawy LED z naszej oferty tj. oczka, klipsy, i taśmy LED.
Versatility: You can connect other LED fixtures to the MASTER - from our offer like spots, clips and LED strips.
Vielseitigkeit: Zu der Master-Leuchte können Sie auch andere LED-Leuchten aus Unserem Sortiment anschließen d.h. Leuchten, LED-Clips und LED-Streifen.

15. ORBIT

Indeks | Index | Index: ORBIT-()-()-01W

Parametry źródła światła | Light source parameters | Parameter der Lichtquelleto:

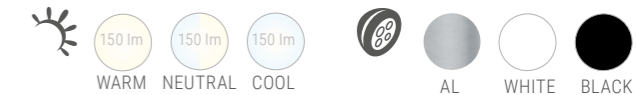

Produkt wyposażony
Containing product
Umgebendes Produkt

Ten produkt zawiera źródło światła o klasie efektywności energetycznej „F”.
This product contains a light source of energy efficiency class „F”.
Dieses Produkt enthält eine Lichtquelle der Energieeffizienzklasse „F”.

12V DC max 1,5W IP20 2 m mini konektor

16. ORBIT RGB

Indeks | Index | Index: ORBIT-AL-RGB-01W



Parametry źródła światła | Light source parameters | Parameter der Lichtquelleto:



17. ORBIT XL

Indeks | Index | Index: ORBIT-XL-()-()-01W



PREMIUM

Parametry źródła światła | Light source parameters | Parameter der Lichtquelleto:

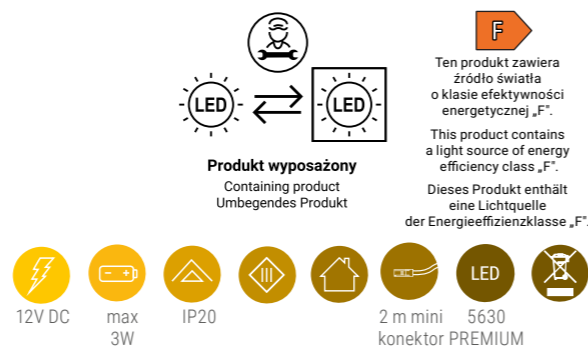
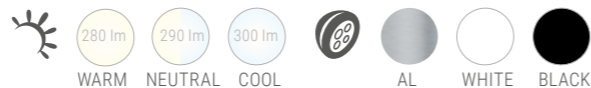

18. ORBIT XL MASTER

Indeks | Index | Index: ORBIT-XL-AL-()-01W



Obciążenie max. wyłącznika 36W.
Max load of the switch 36W.
Maximale Belastung des Schalters 36W.

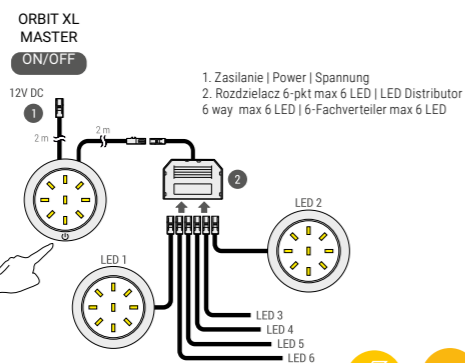

Parametry źródła światła | Light source parameters | Parameter der Lichtquelleto:

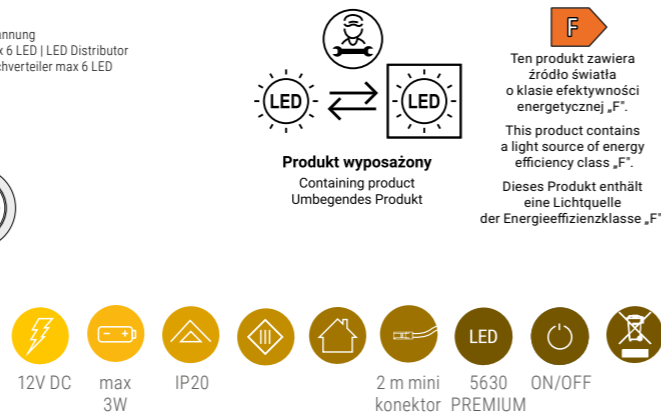

Master steruje oświetleniem LED podłączonym do rozdzielacza. Wystarczy jeden dotyk wyłącznika, aby włączyć/wyłączyć cały układ LED.
Master controls the LED lighting which is connected to it. Just a single touch of the luminaire, to turn on/off the LED lights.
Master steuert die mit ihr verbundenen LED Leuchten. Es reicht eine Berührung um das ganze LED System EIN/AUS zu schalten.



Zeskanuj kod smartfonem i zobacz film jak to działa.
Scan QR code with a smartphone and watch a video of how it works.
Scannen Sie den Code QR mit Ihrem Smartphone und sehen Sie sich das Video an, wie es funktioniert.

19. ORBIT XL ZESTAW 3 PKT | ORBIT XL 3-PTS SET | ORBIT XL 3ER SET

Indeks | Index | Index: ZORM-XL-3P-()-01W



Możliwość rozbudowy zestawu do 4 pkt.
Option of extending the set up to 4 pts.
Das Set ist erweiterbar auf bis zu 4 Leuchten.

Parametry źródła światła | Light source parameters | Parameter der Lichtquelleto:

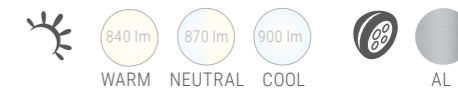

20. ORBIT ZESTAW 3 PKT | ORBIT 3-PTS SET | ORBIT 3ER SET

Indeks | Index | Index: ZORBIT-3P-()-()-V0W



Możliwość rozbudowy zestawu do 6 pkt.
Option of extending the set up to 6 pts.
Das Set ist erweiterbar auf bis zu 6 Leuchten.

Parametry źródła światła | Light source parameters | Parameter der Lichtquelleto:

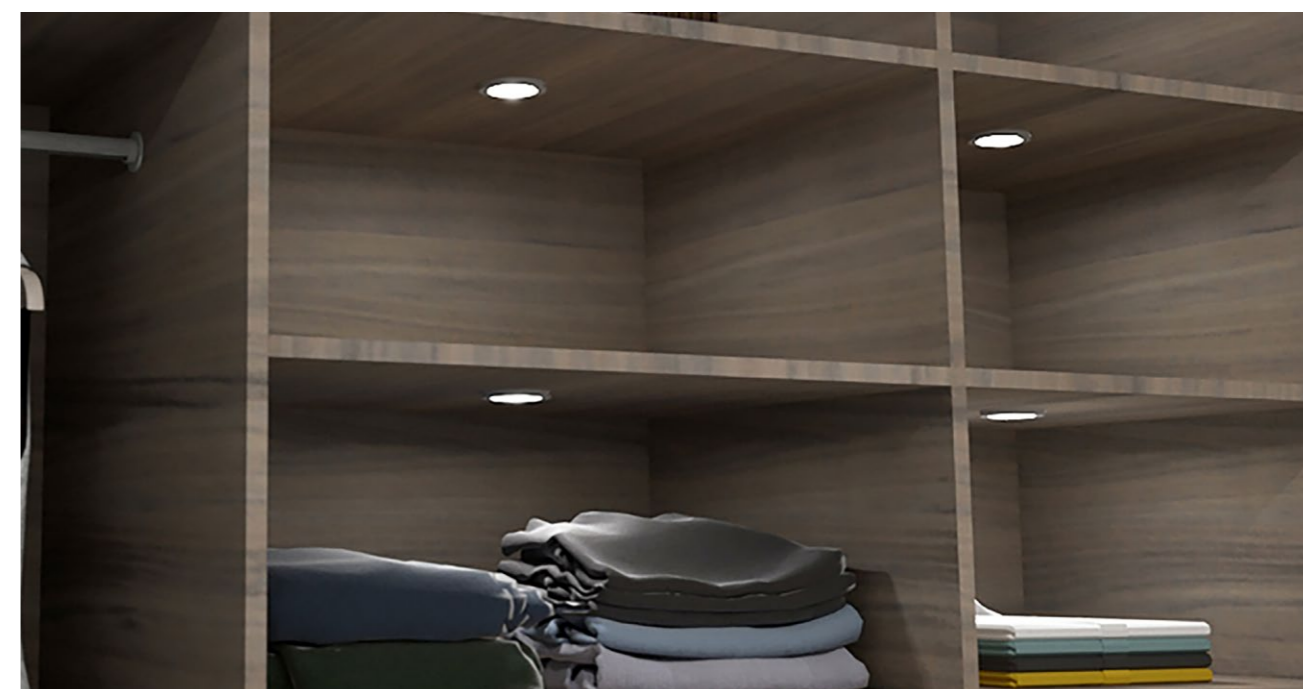
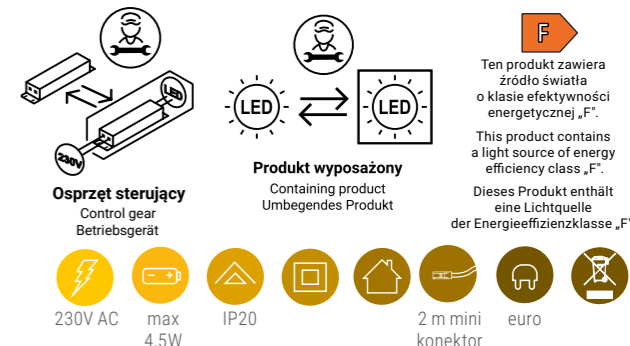
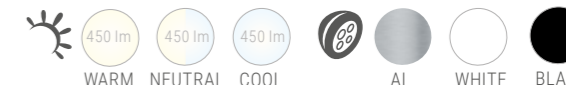

21. MAGNETO

Indeks | Index | Index: MAGNETO-()-01



Oprawę można zamontować nawierzchniowo (A) lub do wpustu (B) – otwór montażowy 56 mm.

The luminaire can be surface-mounted (A) or recessed-mounted (B) - mounting hole 56 mm. Die Leuchte kann als Auf-(A) oder Einbauleuchte montiert (B) werden - 56 mm Montagebohrung.

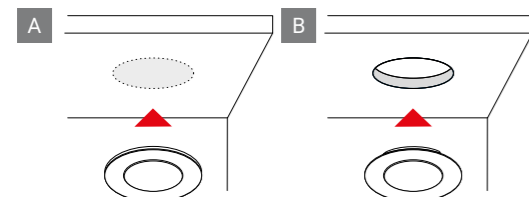

Parametry źródła światła | Light source parameters | Parameter der Lichtquelleto:

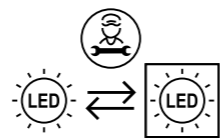

Produkt wyposażony
Containing product
Umgebendes Produkt

Ten produkt zawiera źródło światła o klasie efektywności energetycznej „F+”.
This product contains a light source of energy efficiency class „F+”.
Dieses Produkt enthält eine Lichtquelle der Energieeffizienzklasse „F+”.



Zeskanuj kod smartfonem i zobacz film jak to działa.

Scan QR code with a smartphone and watch a video of how it works.
Scannen Sie den Code QR mit Ihrem Smartphone und sehen Sie sich das Video an, wie es funktioniert.

22. SENSO

Indeks | Index | Index: SENSO-AL-()-01



Parametry źródła światła | Light source parameters | Parameter der Lichtquelleto:

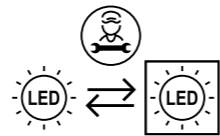

Produkt wyposażony
Containing product
Umgebendes Produkt

Ten produkt zawiera źródło światła o klasie efektywności energetycznej „F+”.
This product contains a light source of energy efficiency class „F+”.
Dieses Produkt enthält eine Lichtquelle der Energieeffizienzklasse „F+”.

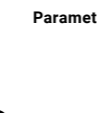

Zeskanuj kod smartfonem i zobacz film jak to działa.

Scan QR code with a smartphone and watch a video of how it works.
Scannen Sie den Code QR mit Ihrem Smartphone und sehen Sie sich das Video an, wie es funktioniert.

23. SENSO MASTER

Indeks | Index | Index: SENSO-M-AL-()-01

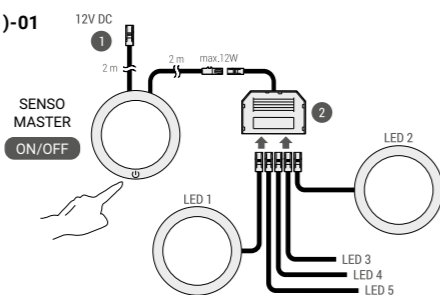

Parametry źródła światła | Light source parameters | Parameter der Lichtquelleto:

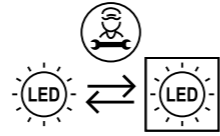

Produkt wyposażony
Containing product
Umgebendes Produkt

Ten produkt zawiera źródło światła o klasie efektywności energetycznej „F+”.
This product contains a light source of energy efficiency class „F+”.
Dieses Produkt enthält eine Lichtquelle der Energieeffizienzklasse „F+”.



Zeskanuj kod smartfonem i zobacz film jak to działa.

Scan QR code with a smartphone and watch a video of how it works.
Scannen Sie den Code QR mit Ihrem Smartphone und sehen Sie sich das Video an, wie es funktioniert.

1. Zasilanie | Power | Spannung
2. Rozdzielacz 6-pkt max 5 LED Senso | LED Distributor 6 way max 5 LED Senso | 6-Fachverteiler max 5 LED Senso

24. SENSO ZESTAW 3 PKT | SENSO 3-PTS SET | SENSO 3ER SET

Indeks | Index | Index: ZSENS-M-3P-AL-()-01W

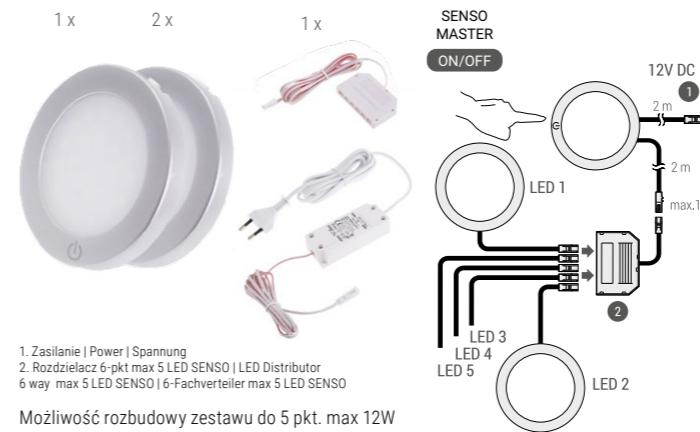

1. Zasilanie | Power | Spannung
2. Rozdzielacz 6-pkt max 5 LED SENSO | LED Distributor 6 way max 5 LED SENSO | 6-Fachverteiler max 5 LED SENSO

Możliwość rozbudowy zestawu do 5 pkt. max 12W
Option of extending the set up to 5 pts max 12W.
Das Set ist erweiterbar auf bis zu 5 Leuchten 12W.



Master steruje oświetleniem LED podłączonym do rozdzielacza. Wystarczy jeden dotyk wyłącznika, aby włączyć/wyłączyć cały układ LED.

Master controls the LED lighting which is connected to it. Just a single touch of the luminaire, to turn on/off the LED lights.
Master steuert die mit ihr verbundenen LED Leuchten. Es reicht eine Berührung um das ganze LED System EIN/AUS zu schalten.

Parametry źródła światła | Light source parameters | Parameter der Lichtquelleto:

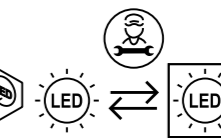
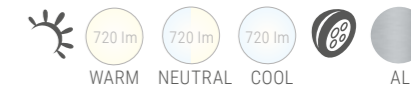

Produkt wyposażony
Containing product
Umgebendes Produkt

Ten produkt zawiera źródło światła o klasie efektywności energetycznej „F+”.
This product contains a light source of energy efficiency class „F+”.
Dieses Produkt enthält eine Lichtquelle der Energieeffizienzklasse „F+”.

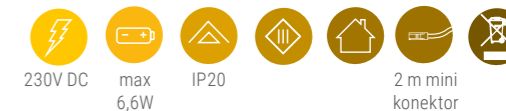

Zeskanuj kod smartfonem i zobacz film jak to działa.

Scan QR code with a smartphone and watch a video of how it works.
Scannen Sie den Code QR mit Ihrem Smartphone und sehen Sie sich das Video an, wie es funktioniert.

25. MASTER

Indeks | Index | Index: MASTER-4,0W-()-01W



Parametry źródła światła | Light source parameters | Parameter der Lichtquelleto:

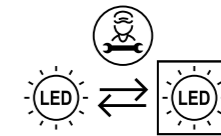
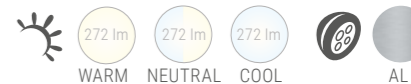

Produkt wyposażony
Containing product
Umgebendes Produkt

Ten produkt zawiera źródło światła o klasie efektywności energetycznej „F+”.
This product contains a light source of energy efficiency class „F+”.
Dieses Produkt enthält eine Lichtquelle der Energieeffizienzklasse „F+”.



Zeskanuj kod smartfonem i zobacz film jak to działa.

Scan QR code with a smartphone and watch a video of how it works.
Scannen Sie den Code QR mit Ihrem Smartphone und sehen Sie sich das Video an, wie es funktioniert.

26. PUPIL

Indeks | Index | Index: PUPIL-4,0W-()-01W



Parametry źródła światła | Light source parameters | Parameter der Lichtquelleto:

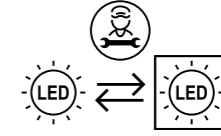
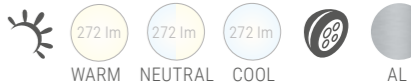

Produkt wyposażony
Containing product
Umgebendes Produkt

Ten produkt zawiera źródło światła o klasie efektywności energetycznej „F+”.
This product contains a light source of energy efficiency class „F+”.
Dieses Produkt enthält eine Lichtquelle der Energieeffizienzklasse „F+”.



Zeskanuj kod smartfonem i zobacz film jak to działa.

Scan QR code with a smartphone and watch a video of how it works.
Scannen Sie den Code QR mit Ihrem Smartphone und sehen Sie sich das Video an, wie es funktioniert.

27. POLARUS P*

Indeks | Index | Index AL: POLP-(Lmm)-()-01W
 WHITE: POLP-(Lmm)-()-01B
 BLACK: POLP-(Lmm)-()-01C

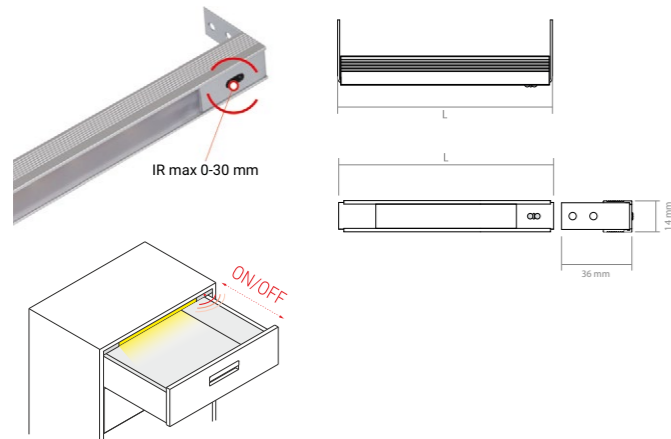

Parametry źródła światła | Light source parameters | Parameter der Lichtquelleto:



Produkt wyposażony
 Containing product
 Umbegendes Produkt

Ten produkt zawiera źródło światła o klasie efektywności energetycznej „F”.
 This product contains a light source of energy efficiency class „F”.
 Dieses Produkt enthält eine Lichtquelle der Energieeffizienzklasse „F”.



Parametry źródła światła | Light source parameters | Parameter der Lichtquelleto:

Moc Power Leistung (W)	3,9	5,5	7,7	8,9	9,9	12,1
Długość Lenth Länge (mm)	414	564	764	864	964	1164
Strumień światła Luminous Flux Bemessungslichtstrom (lm)	390	550	770	880	990	1210



Zeskanuj kod smartfonem i zobacz film jak to działa.
 Scan QR code with a smartphone and watch a video of how it works.
 Scannen Sie den Code QR mit Ihrem Smartphone und sehen Sie sich das Video an, wie es funktioniert.

Wyłącznik zbliżeniowy IR max. 30 mm
 Proximity switch max 30 mm
 Näherungsschalter max. 30 mm

*Długość można zamówić według indywidualnych potrzeb. | Length can be ordered according to individual needs. | Die Länge kann nach individuellen Bedürfnissen bestellt werden.
 *Produkt dostępny również w kolorze czarnym z czarnym kloszem. | Product also available in black with a black diffuser. | Produkt auch in schwarz mit schwarzer Abdeckung erhältlich.

28. DRAŻEK LED Z PIR | LED BAR WITH PIR SENSOR | LED KLEIDERSCHRANKSTANGE MIT PIR-SCHALTER*

Indeks | Index | Index AL: REL-(Lmm)-()-OP-(L/P)-01-R
 BLACK: REL-(Lmm)-()-CZ-OP-(L/P)-01-R

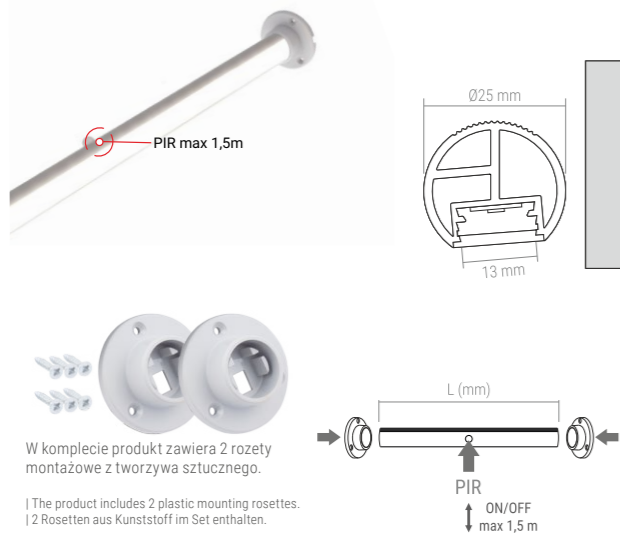

Parametry źródła światła | Light source parameters | Parameter der Lichtquelleto:

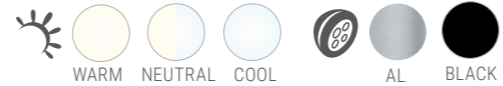

Produkt wyposażony
 Containing product
 Umbegendes Produkt

Ten produkt zawiera źródło światła o klasie efektywności energetycznej „F”.
 This product contains a light source of energy efficiency class „F”.
 Dieses Produkt enthält eine Lichtquelle der Energieeffizienzklasse „F”.



W komplecie produkt zawiera 2 rozety montażowe z tworzywa sztucznego.

The product includes 2 plastic mounting rosettes.
 2 Rosetten aus Kunststoff im Set enthalten.

Zeskanuj kod smartfonem i zobacz film jak to działa.

Scan QR code with a smartphone and watch a video of how it works.
 Scannen Sie den Code QR mit Ihrem Smartphone und sehen Sie sich das Video an, wie es funktioniert.

*Długość można zamówić według indywidualnych potrzeb. | Length can be ordered according to individual needs. | Die Länge kann nach individuellen Bedürfnissen bestellt werden.

29. RELING SLIM*

Indeks | Index | Index: REL-S-(Lmm)-()-()-OP-01U

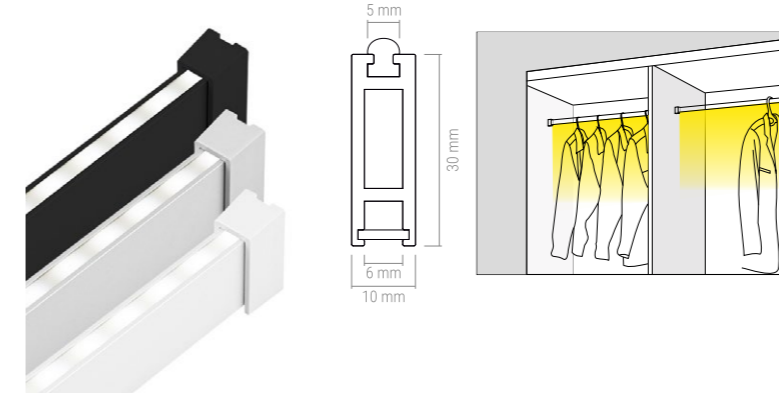

Parametry źródła światła | Light source parameters | Parameter der Lichtquelleto:



Produkt wyposażony
 Containing product
 Umbegendes Produkt

Ten produkt zawiera źródło światła o klasie efektywności energetycznej „F”.
 This product contains a light source of energy efficiency class „F”.
 Dieses Produkt enthält eine Lichtquelle der Energieeffizienzklasse „F”.



Produkt zawiera komplet uchwytów montażowych z tworzywa ABS.

The product includes a set of mounting brackets made of ABS plastic.
 Das Produkt enthält eine Set mit ABS-Montagehalterungen aus Kunststoff.

*Długość można zamówić według indywidualnych potrzeb. | Length can be ordered according to individual needs. | Die Länge kann nach individuellen Bedürfnissen bestellt werden.

30. RELING SLIM PIR*

Indeks | Index | Index: REL-SP-(Lmm)-()-()-()-(L/P)-1U

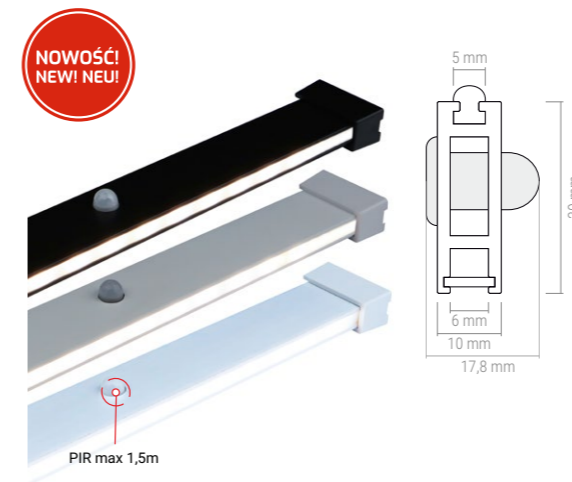

Parametry źródła światła | Light source parameters | Parameter der Lichtquelleto:



Produkt wyposażony
 Containing product
 Umbegendes Produkt

Ten produkt zawiera źródło światła o klasie efektywności energetycznej „F”.
 This product contains a light source of energy efficiency class „F”.
 Dieses Produkt enthält eine Lichtquelle der Energieeffizienzklasse „F”.

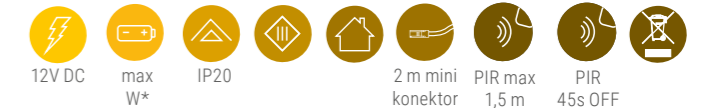

Produkt zawiera komplet uchwytów montażowych z tworzywa ABS.

The product includes a set of mounting brackets made of ABS plastic.
 Das Produkt enthält eine Set mit ABS-Montagehalterungen aus Kunststoff.

*Długość można zamówić według indywidualnych potrzeb. | Length can be ordered according to individual needs. | Die Länge kann nach individuellen Bedürfnissen bestellt werden.

31. FUTURA PIR*

Indeks | Index | Index: FUTP-(Lmm)-()-OP-(L/P)-01W



PIR max 1,5m

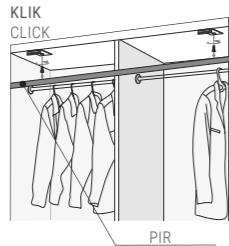
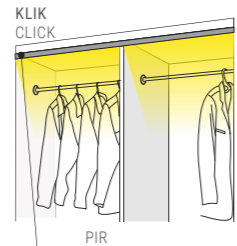
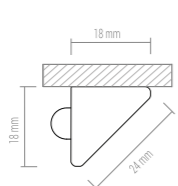

PLASTIKOWE UCHWYTY MONTAŻOWE W KOMPLECIE.

| PLASTIC MOUNTING HOLDERS INCLUDED.
| KUNSTSTOFF-MONTAGEHALTERUNG IM LIEFERUMFANG ENTHALTEN.



Zeskanuj kod smartfonem i zobacz film jak to działa.

Scan QR code with a smartphone and watch a video of how it works.
Scannen Sie den Code QR mit Ihrem Smartphone und sehen Sie sich das Video an, wie es funktioniert.

*Długość można zamówić według indywidualnych potrzeb.

| Length can be ordered according to individual needs.
| Die Länge kann nach individuellen Bedürfnissen bestellt werden.

Parametry źródła światła | Light source parameters | Parameter der Lichtquelleto:

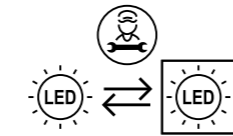
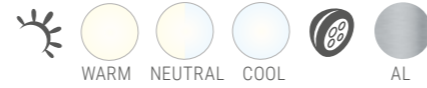

Produkt wyposażony
Containing product
Umbegendes Produkt

Ten produkt zawiera źródło światła o klasie efektywności energetycznej „F”.
This product contains a light source of energy efficiency class „F”.
Dieses Produkt enthält eine Lichtquelle der Energieeffizienzklasse „F”.



32. FUTURA XC*

Indeks | Index | Index: FUTX-(Lmm)-()-OP-(L/P)-01W



XC60

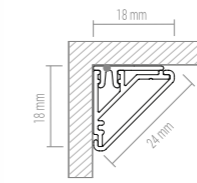

Wyłącznik dotykowy XC60
| TOUCH SWITCH XC60
| TOUCH SCHALTER XC60



PLASTIKOWE UCHWYTY MONTAŻOWE W KOMPLECIE.

| PLASTIC MOUNTING HOLDERS INCLUDED.
| KUNSTSTOFF-MONTAGEHALTERUNGEN IM LIEFERUMFANG ENTHALTEN.



Zeskanuj kod smartfonem i zobacz film jak to działa.

Scan QR code with a smartphone and watch a video of how it works.
Scannen Sie den Code QR mit Ihrem Smartphone und sehen Sie sich das Video an, wie es funktioniert.

*Długość można zamówić według indywidualnych potrzeb.

| Length can be ordered according to individual needs.
| Die Länge kann nach individuellen Bedürfnissen bestellt werden.

Parametry źródła światła | Light source parameters | Parameter der Lichtquelleto:

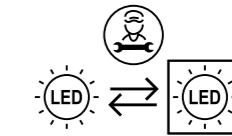
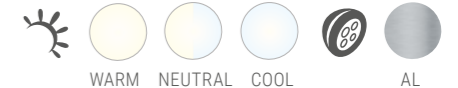

Produkt wyposażony
Containing product
Umbegendes Produkt

Ten produkt zawiera źródło światła o klasie efektywności energetycznej „F”.
This product contains a light source of energy efficiency class „F”.
Dieses Produkt enthält eine Lichtquelle der Energieeffizienzklasse „F”.



33. POLISTAR

Indeks | Index | Index: POLISTAR-()-01W



PREMIUM

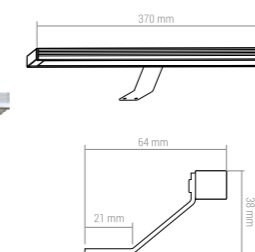

Parametry źródła światła | Light source parameters | Parameter der Lichtquelleto:

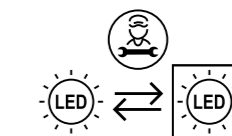

Produkt wyposażony
Containing product
Umbegendes Produkt

Ten produkt zawiera źródło światła o klasie efektywności energetycznej „F”.
This product contains a light source of energy efficiency class „F”.
Dieses Produkt enthält eine Lichtquelle der Energieeffizienzklasse „F”.



34. AMBER UNIWERSALNY | UNIVERSAL

Indeks | Index | Index CH: AMBER-U-()-01
 BLACK: AMBER-U-CZ-()-01
 GOLD: AMBER-U-ZL-()-01

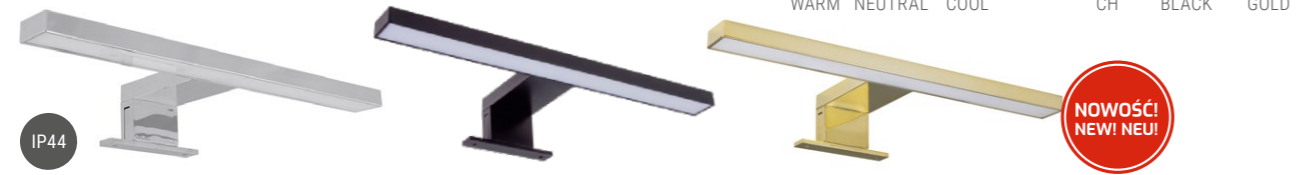

Parametry źródła światła | Light source parameters | Parameter der Lichtquelle:

550 lm WARM 550 lm NEUTRAL 550 lm COOL CH BLACK GOLD

230V AC max 4,5W IP44 30 cm

Oprawa posiada uniwersalny uchwyt montażowy do mocowania na lustrze lub na szafce.
 The luminaire has a universal mounting bracket, possibility of mounting on the mirror or cabinet.
 Die Leuchte mit universeller Halterung zur Montage auf den Spiegel oder auf den Schrank.

Osprzęt sterujący
Control gear
Betriebsgerät

Produkt wyposażony
Containing product
Umbegedenes Produkt

Ten produkt zawiera źródło światła o klasie efektywności energetycznej „E”.
 This product contains a light source of energy efficiency class „E”.
 Dieses Produkt enthält eine Lichtquelle der Energieeffizienzklasse „E”.

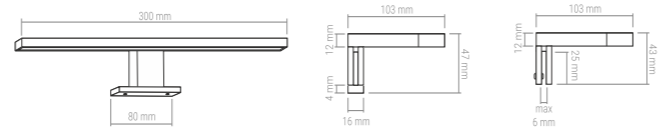

35. LUMI FLOW

Indeks | Index | Index: LUMIF-(Lmm)-40-1-()O-01



Parametry źródła światła | Light source parameters | Parameter der Lichtquelle:

NEUTRAL WHITE AL BLACK

12V DC max W* IP20 2 m mini konektor

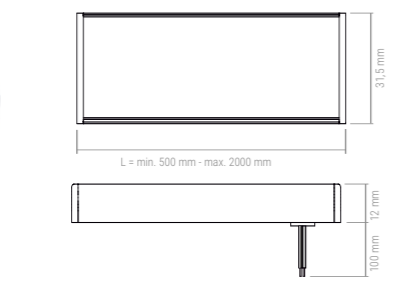

NOWOŚCI! NEWI! NEU!

*Długość można zamówić według indywidualnych potrzeb.
 | Length can be ordered according to individual needs.
 | Die Länge kann nach individuellen Bedürfnissen bestellt werden.



36. STEP LED

Indeks | Index | Index: STEP-()-40K-01

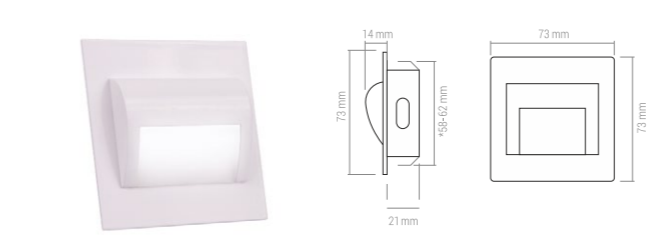

Parametry źródła światła | Light source parameters | Parameter der Lichtquelle:

40 lm NEUTRAL ST AN WHITE BLACK

12V DC max 1,4W IP20 30 cm

Oprawa pasuje do puszki elektrycznej (średnica) 60 mm.
 Luminaire fits to the junction box 60 mm.
 Leuchte passt in den Elektrokasten 60 mm.

37. STAR

Indeks | Index | Index: STAR-CH-()-01

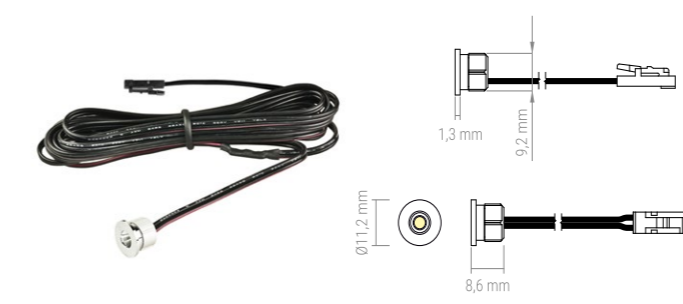

Parametry źródła światła | Light source parameters | Parameter der Lichtquelle:

30 lm WARM 30 lm NEUTRAL 30 lm COOL CH

12V DC max 0,7W IP20 2 m mini konektor Ø9 mm

38. MODUS TOUCH USB

Indeks | Index | Index: MODUS-T-USB-()-30K-01

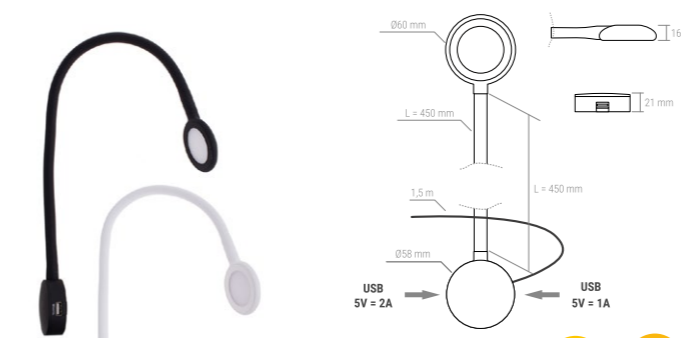

Parametry źródła światła | Light source parameters | Parameter der Lichtquelle:

290 lm WARM WHITE BLACK

Osprzęt sterujący
Control gear
Betriebsgerät

Produkt wyposażony
Containing product
Umbegedenes Produkt

Ten produkt zawiera źródło światła o klasie efektywności energetycznej „E”.
 This product contains a light source of energy efficiency class „E”.
 Dieses Produkt enthält eine Lichtquelle der Energieeffizienzklasse „E”.

12V DC max 2W USB input 5V DC max 2A IP20 1,5 m mini 2 x USB konektor





KLIPSY LED

LED CLIPS
LED CLIPS

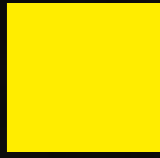

39. KLIPS LED METALOWY | LED CLIP METAL | LED CLIP METALL

Indeks | Index | Index: KLIPS-M-3528-(☀️)-01

Parametry źródła światła | Light source parameters | Parameter der Lichtquelleto:

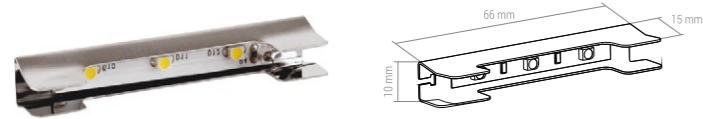
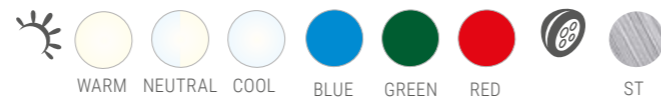

40. KLIPS LED PVC TRANSPARENT | LED CLIP PVC TRANSPARENT | LED CLIP PVC TRANSPARENT

Indeks | Index | Index: KLIPS-P-3528-(☀️)-01

Parametry źródła światła | Light source parameters | Parameter der Lichtquelleto:



41. KLIPS LED RGB | LED RGB CLIP | LED RGB CLIP

LED PVC TRANSPARENT Indeks | Index | Index: PRFT-RGB-0063-MN-02

LED CLIP METAL Indeks | Index | Index: KLIP-RGB066x06-2M-02

Parametry źródła światła | Light source parameters | Parameter der Lichtquelleto:

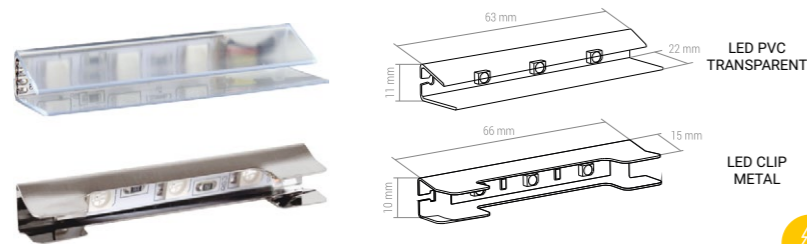

42. KLIPSY LED MONO ZESTAW | LED CLIPS MONO SET | LED CLIPS MONO SET

LED PVC TRANSPARENT Indeks | Index | Index: ZPRFT-2-(☀️)-01W
LED CLIP METAL Indeks | Index | Index: ZZ-KLIP-2-(☀️)-01W

Parametry źródła światła | Light source parameters | Parameter der Lichtquelleto:

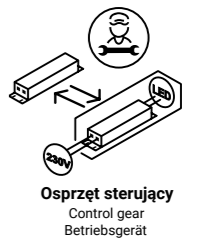
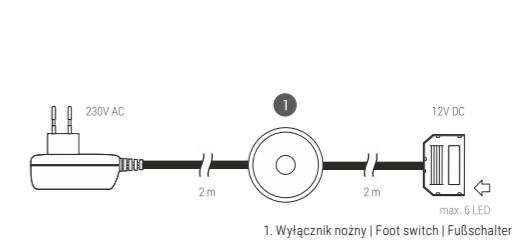
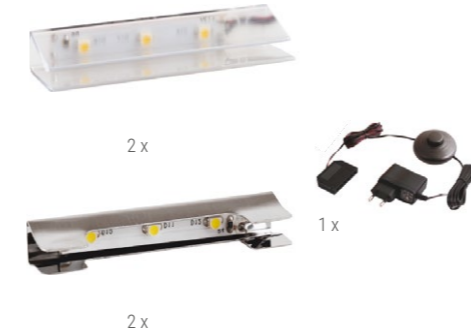

Możliwość rozbudowy zestawu do 6 pkt.
Option of extending the set up to 6 pts.
Das Set ist erweiterbar auf bis zu 6 Leuchten.

43. KLIPSY LED RGB ZESTAW | LED CLIPS RGB SET | LED CLIPS RGB SET

LED PVC TRANSPARENT Indeks | Index | Index: ZPRFT-2-RGB-01W
LED CLIP METAL Indeks | Index | Index: ZZ-KLIP-2-RGB-9-01

Parametry źródła światła | Light source parameters | Parameter der Lichtquelleto:

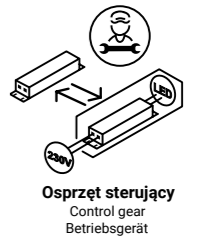
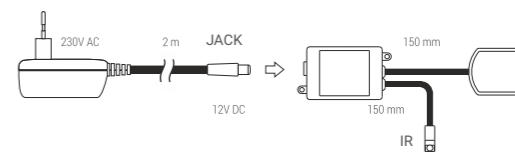
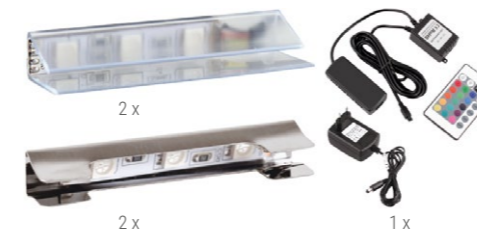

Możliwość rozbudowy zestawu do 9 pkt.
Option of extending the set up to 9 pts.
Das Set ist erweiterbar auf bis zu 9 Leuchten.

44. KLIPS 3D | LED CLIP 3D | LED CLIP 3D

Indeks | Index | Index: KLIPS-3D-(☀️)-(☀️)-01

Parametry źródła światła | Light source parameters | Parameter der Lichtquelleto:

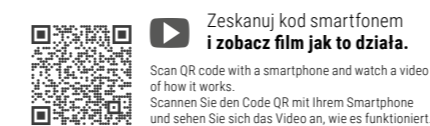
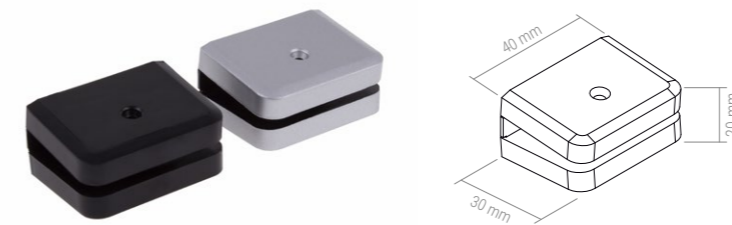

Scan QR code with a smartphone and watch a video of how it works.
Scannen Sie den Code QR mit Ihrem Smartphone und sehen Sie sich das Video an, wie es funktioniert.

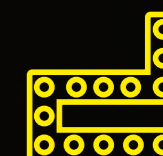

TAŚMY LED

LED STRIPS
LED STREIFEN



45. TAŚMA 60 LED/M PREMIUM TYP 2835 BEZ ŻELU IP20 | LED STRIP 60 LED/M PREMIUM TYPE 2835 WITHOUT GEL IP20 | LED STREIFEN 60 LED/M PREMIUM 2835 OHNE GEL IP20

Indeks | Index | Index: R-2835-300-20-()-02

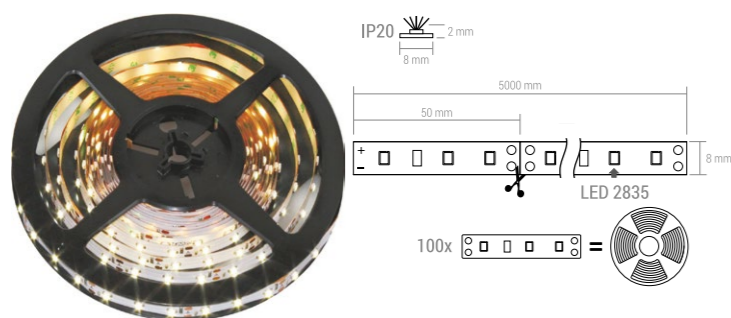

Parametry źródła światła | Light source parameters | Parameter der Lichtquelle:

~1100 lm/m ~1100 lm/m ~1100 lm/m

WARM NEUTRAL COOL BLUE GREEN RED

12V DC max 11W/m IP20 LED 2835 PREMIUM

PREMIUM

46. TAŚMA SNAKE 60 LED/M PREMIUM TYP 2835 BEZ ŻELU IP20 | LED STRIP SNAKE 60 LED/M PREMIUM TYPE 2835 WITHOUT GEL IP20 | LED STREIFEN SNAKE 60 LED/M PREMIUM TYP 2835 OHNE GEL IP20

Indeks | Index | Index: R-2835-SN-20-()-01

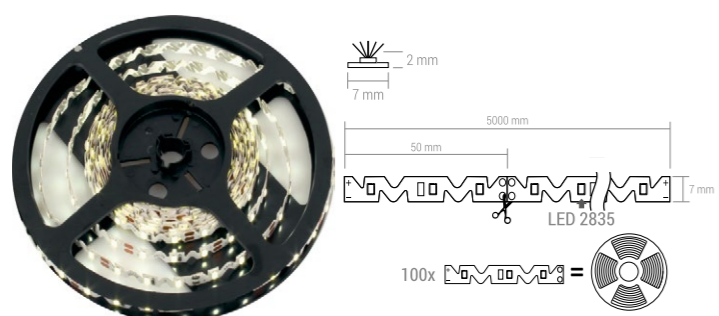

Parametry źródła światła | Light source parameters | Parameter der Lichtquelle:

~840 lm/m ~840 lm/m ~840 lm/m

WARM NEUTRAL COOL

12V DC max 9W/m IP20 LED 2835 PREMIUM

PREMIUM

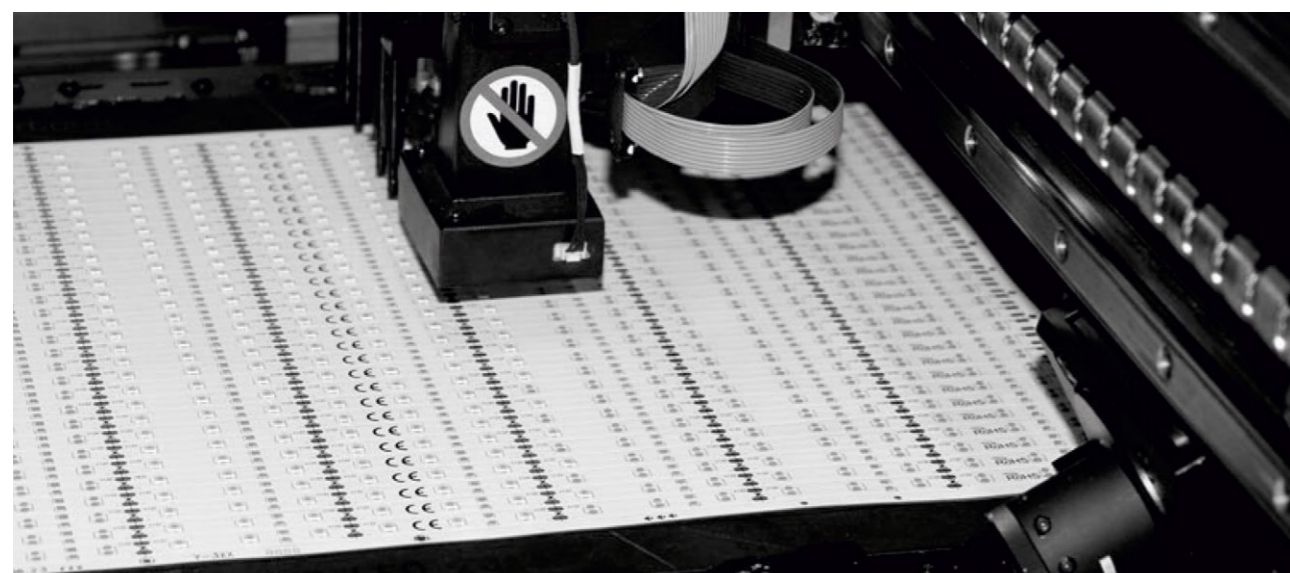

47. TAŚMA 120 LED/M PREMIUM TYP 2835 BEZ ŻELU IP20 | LED STRIP 120 LED/M PREMIUM TYPE 2835 WITHOUT GEL IP20 | LED STREIFEN 120 LED/M PREMIUM 2835 OHNE GEL IP20

Indeks | Index | Index: R-2835-600-20-()-02

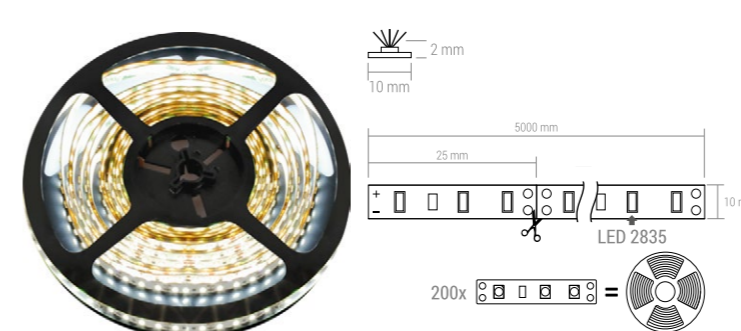

Parametry źródła światła | Light source parameters | Parameter der Lichtquelle:

~1900 lm/m ~1900 lm/m ~1900 lm/m

WARM NEUTRAL COOL

12V DC max 18W/m IP20 LED 2835 PREMIUM

PREMIUM

48. TAŚMA 60 LED/M PREMIUM TYP 5630 BEZ ŻELU IP20 | LED STRIP 60 LED/M PREMIUM TYPE 5630 WITHOUT GEL IP20 | LED STREIFEN 60 LED/M PREMIUM 5630 OHNE GEL IP20

IP20 Indeks | Index | Index: R-5630-300-20-()-02



Parametry źródła światła | Light source parameters | Parameter der Lichtquelle:

~1360 lm/m ~1360 lm/m ~1360 lm/m

WARM NEUTRAL COOL

12V DC max 14W/m IP45 IP20 LED 5630 PREMIUM

PREMIUM

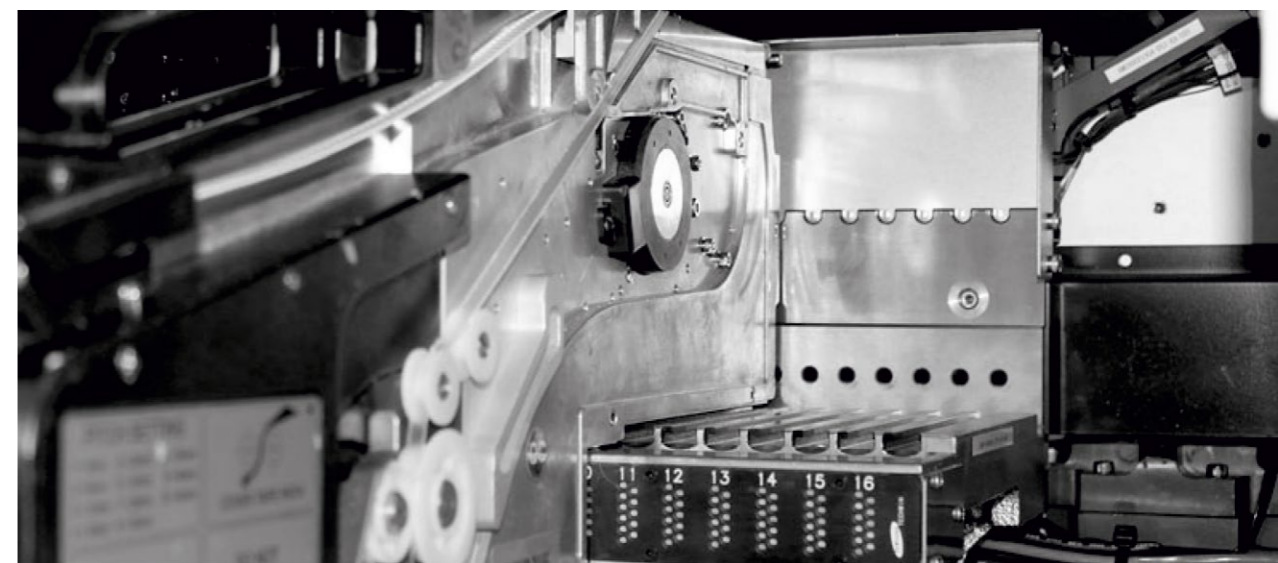

49. TAŚMA 5 MM 60 LED/M TYP 2835 BEZ ŻELU IP20 | LED STRIP 5 MM 60 LED/M TYPE 2835 WITHOUT IP20 GEL | LED STREIFEN 5MM 60 LED/M 2835 OHNE IP20 GEL

Indeks | Index | Index: R-2835-300-20-5MM-()-02

Parametry źródła światła | Light source parameters | Parameter der Lichtquelle:

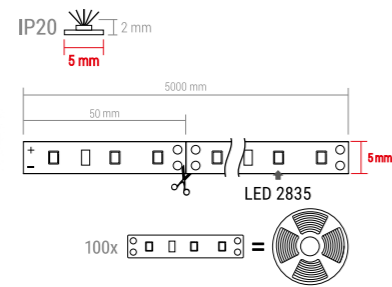

~1100 lm/m WARM NEUTRAL COOL

12V DC max 11W/m IP20 LED 2835 PREMIUM

50. TAŚMA 30 LED/M RGB TYP 5050 WODOODPORNĄ W ŻELU IP45 LUB BEZ ŻELU IP20 | LED STRIP 30 LED/M RGB TYPE 5050 WATERPROOF, IN GEL IP45 OR WITHOUT GEL IP20 | LED STREIFEN 30 LED/M RGB 5050 WASSERDICHT, IN GEL IP45 ODER OHNE GEL IP20

IP45 Indeks | Index | Index: R-LFL3-10MM-150-RGB

IP20 Indeks | Index | Index: R-LDL3-10MM-150-RGB

Parametry źródła światła | Light source parameters | Parameter der Lichtquelle:

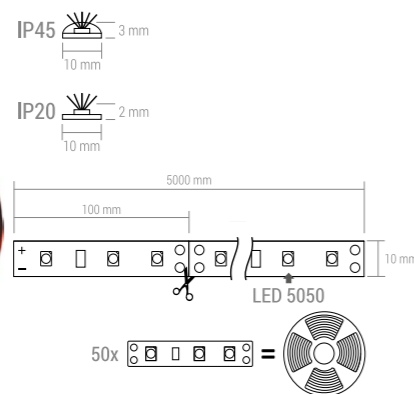

RGB

12V DC max 6W/m IP45 IP20 LED 5050

51. TAŚMA 60 LED/M RGB TYP 5050 WODOODPORNĄ W ŻELU IP45 LUB BEZ ŻELU IP20 | LED STRIP 60 LED/M RGB TYPE 5050 WATERPROOF WITH GEL IP45 OR WITHOUT GEL IP20 | LED STREIFEN 60 LED/M RGB 5050 WASSERDICHT MIT GEL IP45 ODER OHNE GEL IP20

IP45 Indeks | Index | Index: R-LFL3-10MM-300-RGB

IP20 Indeks | Index | Index: R-LDL3-10MM-300-RGB

Parametry źródła światła | Light source parameters | Parameter der Lichtquelle:

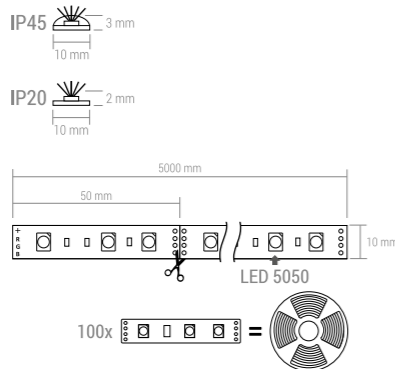

RGB

12V DC max 12W/m IP45 IP20 LED 5050

52. TAŚMA 60 LED/M TYP RGBW BEZ ŻELU IP20 | LED STRIP 60 LED/M TYPE RGBW WITHOUT GEL IP20 | LED STREIFEN 60 LED/M RGBW OHNE GEL IP20

Indeks | Index | Index: R-LDL3-12MM-300-RGBW-01

Parametry źródła światła | Light source parameters | Parameter der Lichtquelle:

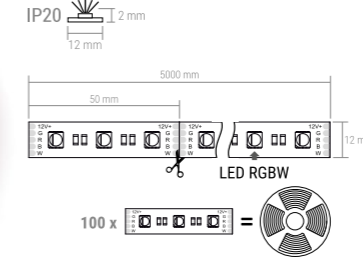

~460 lm/m RGB NEUTRAL

12V DC max 14W/m NEUTRAL max 5,2W/m

Zeskanuj kod smartfonem i zobacz film jak to działa.
Scan QR code with a smartphone and watch a video of how it works.
Scannen Sie den Code QR mit Ihrem Smartphone und sehen Sie sich das Video an, wie es funktioniert.

53. TAŚMA 120 LED/M BICOLOR TYP 2835 BEZ ŻELU IP20 | LED STRIP 120 LED/M BICOLOR, TYPE 2835 WITHOUT GEL IP20 | LED STREIFEN 120 LED/M BICOLOR 2835 OHNE GEL IP20

Indeks | Index | Index: R-2835-600-20-BIK-02

Parametry źródła światła | Light source parameters | Parameter der Lichtquelle:

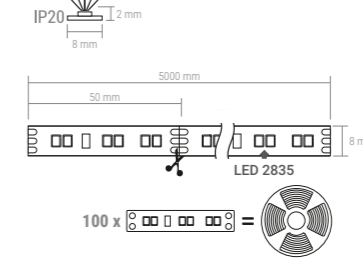

BICOLOR WARM WARM* COOL*
~1040 lm/m ~520 lm/m ~560 lm/m

Umożliwia zmianę barwy światła pomiędzy ciepłą a zimną.
Allows you to change the color of light between warm and cool white.
Ermöglicht die Lichtfarbe zwischen warm und kalt zu ändern.

Zeskanuj kod smartfonem i zobacz film jak to działa.
Scan QR code with a smartphone and watch a video of how it works.
Scannen Sie den Code QR mit Ihrem Smartphone und sehen Sie sich das Video an, wie es funktioniert.

12V DC max 10W/m** 5W/m* IP20 LED 2835

* Barwa referencyjna wg.: Rozporządzenie delegowane Komisji (UE) 2019/2015 z dnia 11 marca 2019 r., | Reference color by: Commission Delegated Regulation (EU) 2019/2015 of 11 March 2019, | Referenzfarbe nach: Delegierte Verordnung (EU) 2019/2015 der Kommission vom 11. März 2019.
** Parametry znamionowe | Rated parameters | Bewertete Parameter

54. TAŚMA 120 LED/M BICOLOR TYP 2835 BEZ ŻELU IP20 24V DC | LED STRIP 120 LED/M BICOLOR, TYPE 2835 WITHOUT GEL IP20 24V DC | LED STREIFEN 120 LED/M BICOLOR 2835 OHNE GEL IP20 24V DC

Indeks | Index | Index: R-24-2835-600-20-BIK-02

Parametry źródła światła | Light source parameters | Parameter der Lichtquelle:

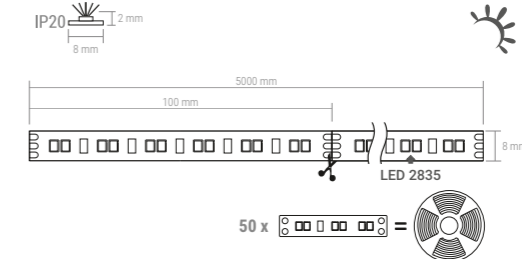

BICOLOR WARM WARM* COOL*
~1020 lm/m ~500 lm/m ~520 lm/m



Umożliwia zmianę barwy światła pomiędzy ciepłą a zimną.
Allows you to change the color of light between warm and cool white.
Ermöglicht die Lichtfarbe zwischen warm und kalt zu ändern.

* Barwa referencyjna wg.: Rozporządzenie delegowane Komisji (UE) 2019/2015 z dnia 11 marca 2019 r., | Reference color by: Commission Delegated Regulation (EU) 2019/2015 of 11 March 2019, | Referenzfarbe nach: Delegierte Verordnung (EU) 2019/2015 der Kommission vom 11. März 2019.
** Parametry znamionowe | Rated parameters | Bewertete Parameter

24V DC max 10,8W/m** 5,4W/m* IP20 LED 2835

TAŚMY LED PRODUKCJI POLSKIEJ
| LED STRIPS OF POLISH PRODUCTION | LED-STREIFEN DER POLNISCHEN PRODUKTION

55. TAŚMA 60 LED/M PREMIUM TYP 2835 BEZ ŻELU IP20 ROLKA 50 M | LED STRIP 60 LED/M PREMIUM TYPE 2835 WITHOUT GEL IP20 ROLL 50 M | LED STREIFEN 60 LED/M PREMIUM 2835 OHNE GEL IP20 ROLLE 50 M

Indeks | Index | Index: R-2835-50M-20-()-04

Parametry źródła światła | Light source parameters | Parameter der Lichtquelle:

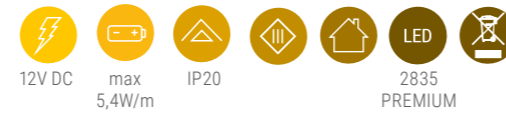
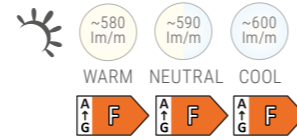
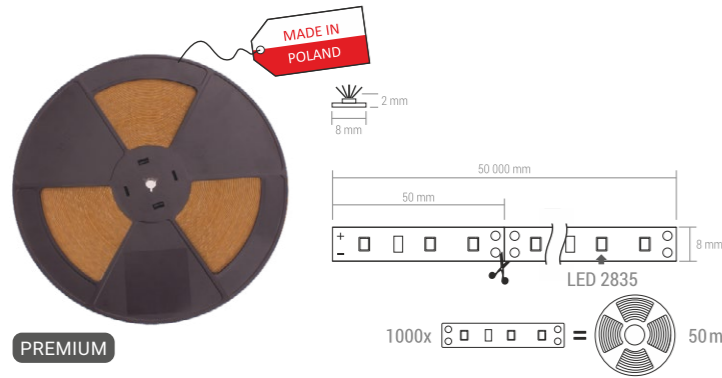

56. TAŚMA 60 LED/M PREMIUM TYP 2835 BEZ ŻELU IP20 ROLKA 50 M | LED STRIP 60 LED/M PREMIUM TYPE 2835 WITHOUT GEL IP20 ROLL 50 M | LED STREIFEN 60 LED/M PREMIUM 2835 OHNE GEL IP20 ROLLE 50 M

Indeks | Index | Index: R-2835-50M-20-()-01

Parametry źródła światła | Light source parameters | Parameter der Lichtquelle:

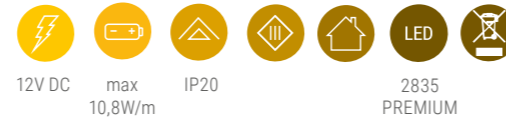
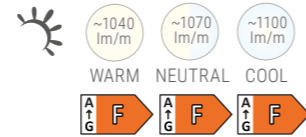
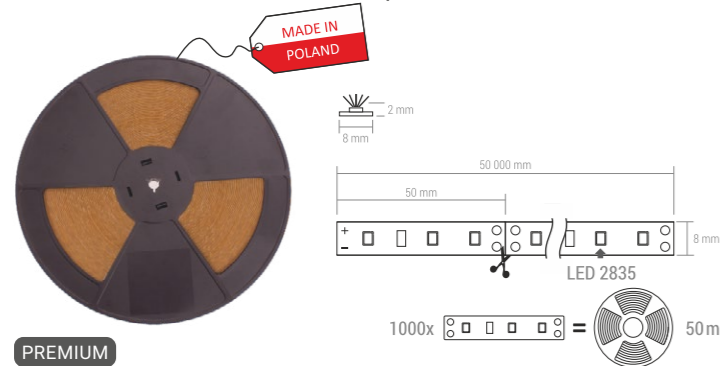

57. TAŚMA 120 LED/M PREMIUM TYP 2835 BEZ ŻELU IP20 ROLKA 50 M | LED STRIP 120 LED/M PREMIUM TYPE 2835 WITHOUT GEL IP20 ROLL 50 M | LED STREIFEN 120 LED/M PREMIUM 2835 OHNE GEL IP20 ROLLE 50 M

Indeks | Index | Index: R-2835-50M-20-()-03

Parametry źródła światła | Light source parameters | Parameter der Lichtquelle:

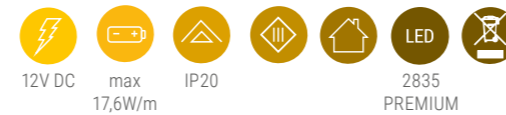
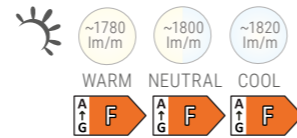
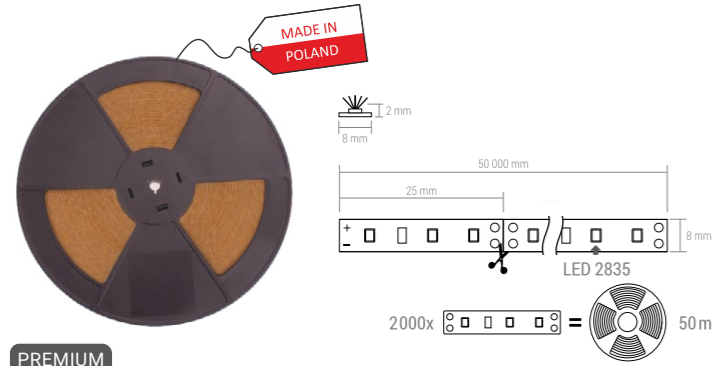

Taśma LED w rolce 50 m to:
 - łatwiejszy montaż,
 - oszczędność czasu,
 - zminimalizowanie strat materiałowych,
 - możliwość cięcia taśmy na odcinki dowolnej długości.

The LED strip in roll 50 m:
 - easier assemble,
 - saving time,
 - minimize material losses,
 - ability to cut the tape to any length.

LED-Streifen in Rolle 50 m:
 - einfachere Montage,
 - Zeiteinsparung,
 - Minimierung von Materialverlusten,
 - Möglichkeit, den Streifen auf beliebige Länge zu schneiden.

Nie łączyć w odcinki dłuższe niż 5 metrów!

Do not connect in lengths longer than 5 m!

Abschnitte dürfen nicht länger als 5 m sein!

58. TAŚMA 30 LED/M PREMIUM TYP 2835 BEZ ŻELU IP20 ROLKA 5 M | LED STRIP 30 LED/M PREMIUM TYPE 2835 WITHOUT GEL IP20 ROLL 5 M | LED STREIFEN 30 LED/M PREMIUM 2835 OHNE GEL IP20 ROLLE 5 M

Parametry źródła światła | Light source parameters | Parameter der Lichtquelle:

Indeks | Index | Index: R-2835-150-20-()-03

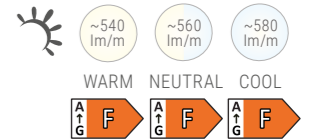

59. TAŚMA 60 LED/M PREMIUM TYP 2835 WODOODPORNĄ W ŻELU IP45 LUB BEZ ŻELU IP20 ROLKA 5 M | LED STRIP 60 LED/M PREMIUM TYPE 2835 WATERPROOF, IN GEL IP45 OR WITHOUT GEL IP20 ROLL 5 M | LED STREIFEN 60 LED/M PREMIUM 2835 WASSERDICHT, IN GEL IP45 ODER OHNE GEL IP20 ROLLE 5 M

Parametry źródła światła | Light source parameters | Parameter der Lichtquelle:

IP45 Indeks | Index | Index: R-2835-300-45-()-03

IP20 Indeks | Index | Index: R-2835-300-20-()-03

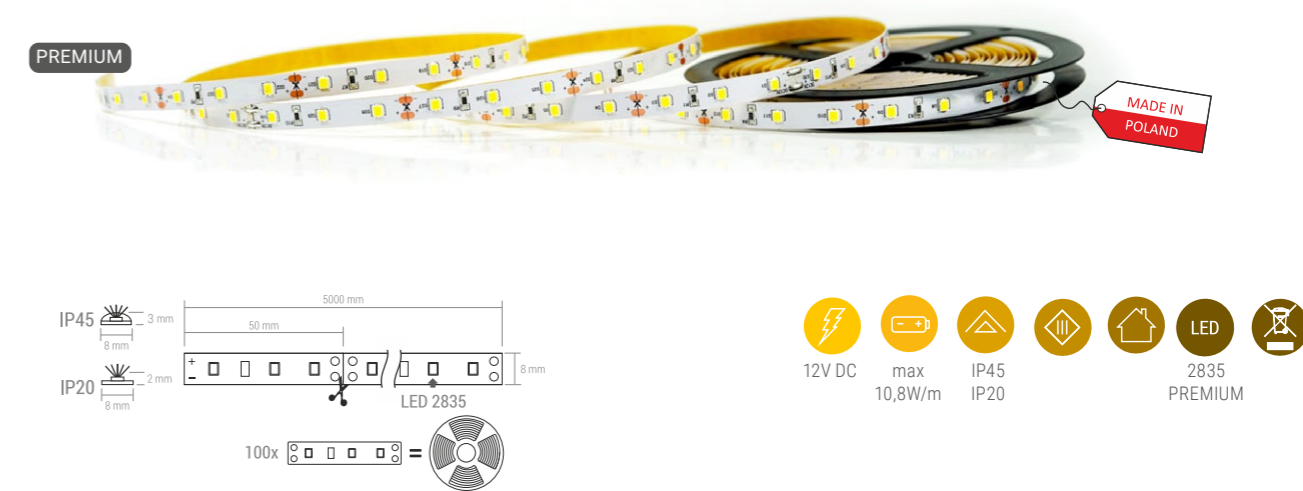
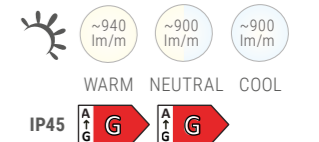
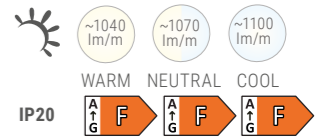

60. TAŚMA 120 LED/M PREMIUM TYP 2835 BEZ ŻELU IP20 ROLKA 5 M | LED STRIP 120 LED/M PREMIUM TYPE 2835 WITHOUT GEL IP20 ROLL 5 M | LED STREIFEN 120 LED/M PREMIUM 2835 OHNE GEL IP20 ROLLE 5 M

Parametry źródła światła | Light source parameters | Parameter der Lichtquelle:

Indeks | Index | Index: R-2835-600-20-()-03

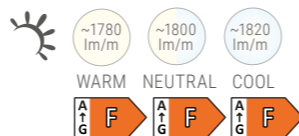

PREMIUM

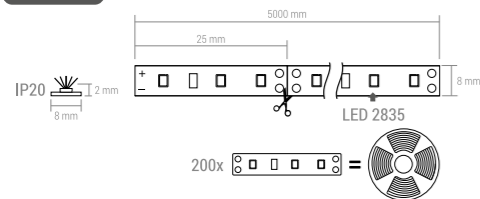

61. TAŚMA 60 LED/M PREMIUM 24V DC TYP 2835 BEZ ŻELU IP20 ROLKA 5 M | LED STRIP 60 LED/M PREMIUM 24V DC TYPE 2835 WITHOUT GEL IP20 ROLL 5 M | LED STREIFEN 60 LED/M PREMIUM 24V DC 2835 OHNE GEL IP20 ROLLE 5 M

Parametry źródła światła | Light source parameters | Parameter der Lichtquelle:

Indeks | Index | Index: R-24-2835-5-20-()-01

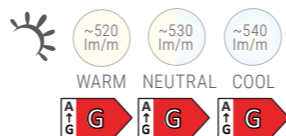

PREMIUM

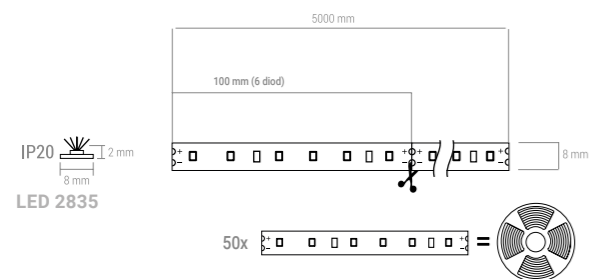

62. TAŚMA 120 LED/M PREMIUM 24V DC TYP 2835 BEZ ŻELU IP20 ROLKA 5 M | LED STRIP 120 LED/M PREMIUM 24V DC TYPE 2835 WITHOUT GEL IP20 ROLL 5 M | LED STREIFEN 120 LED/M PREMIUM 24V DC 2835 OHNE GEL IP20 ROLLE 5 M

Parametry źródła światła | Light source parameters | Parameter der Lichtquelle:

Indeks | Index | Index: R-24-2835-5-20-()-02

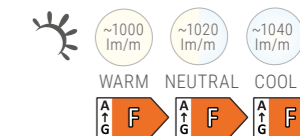

PREMIUM

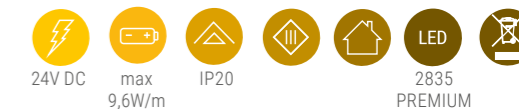
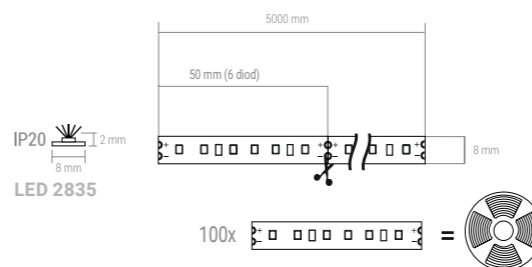

63. TAŚMA 120 LED/M PREMIUM 24V DC TYP 2835 BEZ ŻELU IP20 ROLKA 5 M | LED STRIP 120 LED/M PREMIUM 24V DC TYPE 2835 WITHOUT GEL IP20 ROLL 5 M | LED STREIFEN 120 LED/M PREMIUM 24V DC 2835 OHNE GEL IP20 ROLLE 5 M

Parametry źródła światła | Light source parameters | Parameter der Lichtquelle:

Indeks | Index | Index: R-24-2835-5-20-()-04

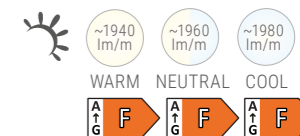

PREMIUM

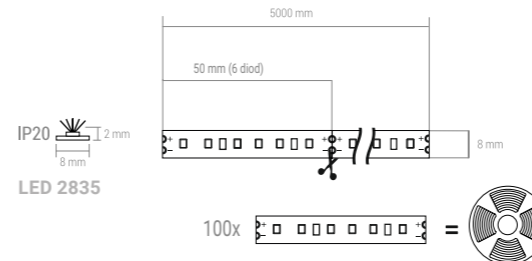

64. TAŚMA 60 LED/M PREMIUM 24V DC TYP 2835 BEZ ŻELU IP20 ROLKA 5 M | LED STRIP 60 LED/M PREMIUM 24V DC TYPE 2835 WITHOUT GEL IP20 ROLL 5 M | LED STREIFEN 60 LED/M PREMIUM 24V DC 2835 OHNE GEL IP20 ROLLE 5 M

Parametry źródła światła | Light source parameters | Parameter der Lichtquelle:

Indeks | Index | Index: R-24-2835-5-20-()-05

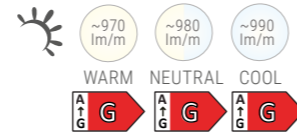

PREMIUM

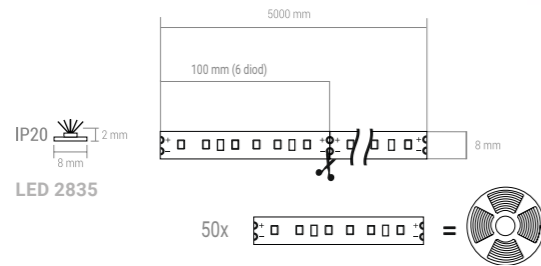

65. TAŚMA 60 LED/M PREMIUM 24V DC TYP 2835 BEZ ŻELU IP20 ROLKA 50 M | LED STRIP 60 LED/M PREMIUM 24V DC TYPE 2835 WITHOUT GEL IP20 ROLL 50 M | LED STREIFEN 60 LED/M PREMIUM 24V DC 2835 OHNE GEL IP20 ROLLE 50 M

Parametry źródła światła | Light source parameters | Parameter der Lichtquelle:

Indeks | Index | Index: R-24-2835-50-20-()-01

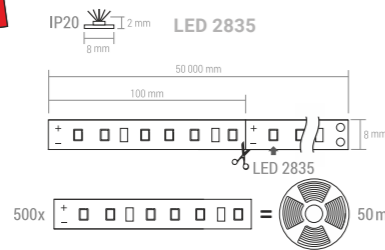
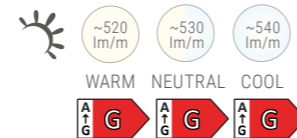

66. TAŚMA 120 LED/M PREMIUM 24V DC TYP 2835 BEZ ŻELU IP20 ROLKA 50 M | LED STRIP 120 LED/M PREMIUM 24V DC TYPE 2835 WITHOUT GEL IP20 ROLL 50 M | LED STREIFEN 120 LED/M PREMIUM 24V DC 2835 OHNE GEL IP20 ROLLE 50 M

Parametry źródła światła | Light source parameters | Parameter der Lichtquelle:

Indeks | Index | Index: R-24-2835-50-20-()-02

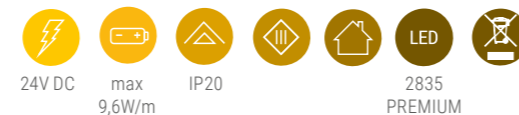
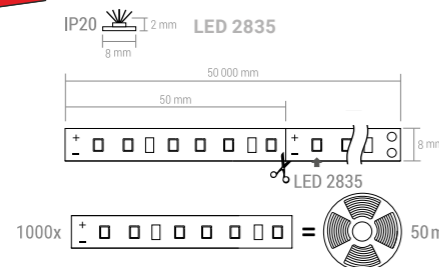
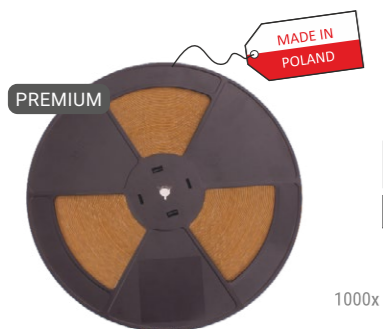
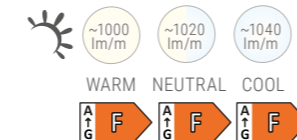

67. TAŚMA 120 LED/M PREMIUM 24V DC TYP 2835 BEZ ŻELU IP20 ROLKA 50 M | LED STRIP 120 LED/M PREMIUM 24V DC TYPE 2835 WITHOUT GEL IP20 ROLL 50 M | LED STREIFEN 120 LED/M PREMIUM 24V DC 2835 OHNE GEL IP20 ROLLE 50 M

Parametry źródła światła | Light source parameters | Parameter der Lichtquelle:

Indeks | Index | Index: R-24-2835-50M-20-()-04

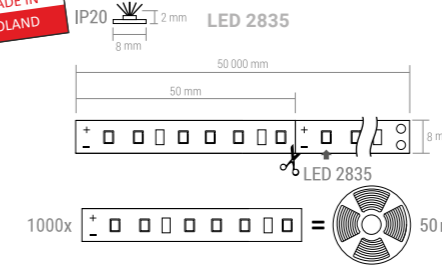
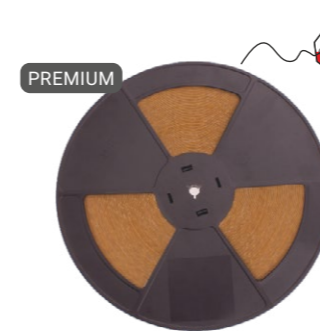
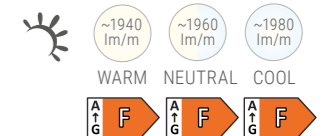

Taśma LED w rolce 50 m to:
- łatwiejszy montaż,
- oszczędność czasu,
- zminimalizowanie strat materiałowych,
- możliwość cięcia taśmy na odcinki dowolnej długości.

The LED strip in roll 50 m:
- easier assemble,
- saving time,
- minimize material losses,
- ability to cut the tape to any length.

LED-Streifen in Rolle 50 m:
- einfachere Montage,
- Zeiteinsparung,
- Minimierung von Materialverlusten,
- Möglichkeit, den Streifen auf beliebige Länge zu schneiden.

Nie łączyć w odcinki dłuższe niż 5 metrów!

Do not connect in lengths longer than 5 m!

Abschnitte dürfen nicht länger als 5 m sein!

68. TAŚMA 60 LED/M PREMIUM 24V DC TYP 2835 BEZ ŻELU IP20 ROLKA 50 M | LED STRIP 60 LED/M PREMIUM 24V DC TYPE 2835 WITHOUT GEL IP20 ROLL 50 M | LED STREIFEN 60 LED/M PREMIUM 24V DC 2835 OHNE GEL IP20 ROLLE 50 M

Parametry źródła światła | Light source parameters | Parameter der Lichtquelle:

Indeks | Index | Index: R-24-2835-50M-20-()-05

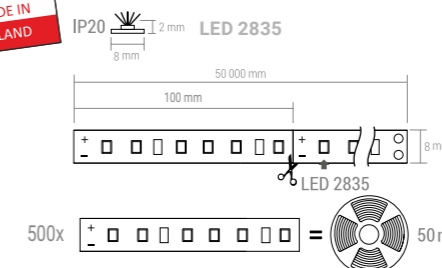
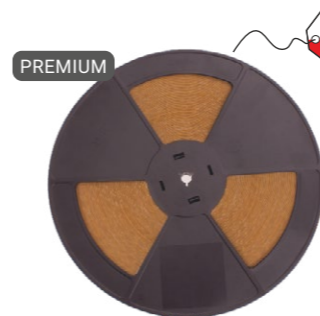
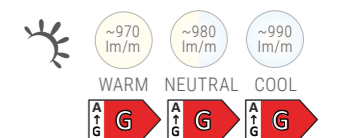

Taśma LED w rolce 50 m to:
- łatwiejszy montaż,
- oszczędność czasu,
- zminimalizowanie strat materiałowych,
- możliwość cięcia taśmy na odcinki dowolnej długości.

The LED strip in roll 50 m:
- easier assemble,
- saving time,
- minimize material losses,
- ability to cut the tape to any length.

LED-Streifen in Rolle 50 m:
- einfachere Montage,
- Zeiteinsparung,
- Minimierung von Materialverlusten,
- Möglichkeit, den Streifen auf beliebige Länge zu schneiden.

Nie łączyć w odcinki dłuższe niż 5 metrów!

Do not connect in lengths longer than 5 m!

Abschnitte dürfen nicht länger als 5 m sein!

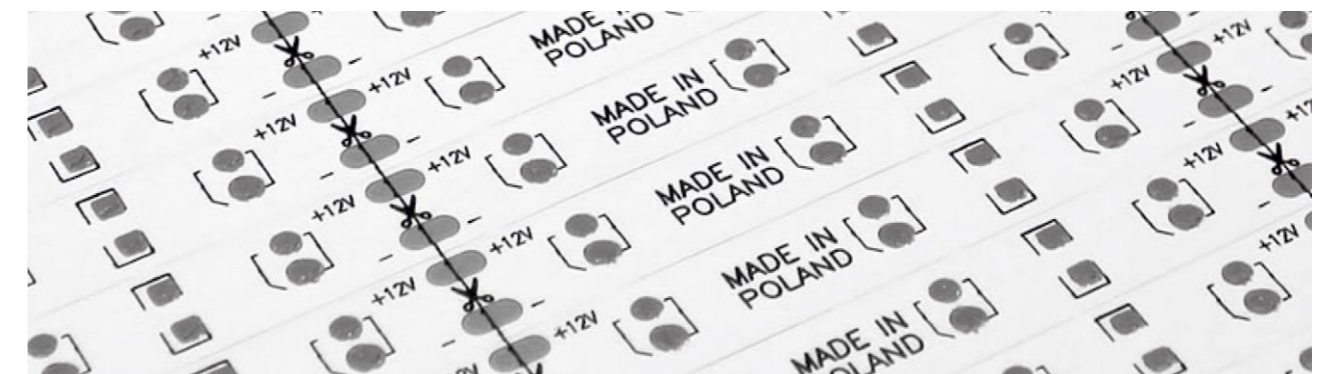

TAŚMY LED PRODUKCJI POLSKIEJ Z DIODAMI SAMSUNG
| LED STRIPS OF POLISH PRODUCTION WITH SAMSUNG DIODES | LED-STREIFEN
DER POLNISCHEN PRODUKTION MIT SAMSUNG LEDS

69. TAŚMA 60 LED/M PREMIUM Z DIODAMI SAMSUNG TYP 2835 BEZ ŻELU IP20 ROLKA 5 M | LED STRIP 60 LED/M PREMIUM WITH SAMSUNG DIODES TYPE 2835 WITHOUT GEL IP20 ROLL 5 M | LED STREIFEN 60 LED/M PREMIUM MIT SAMSUNG LEDS 2835 OHNE GEL IP20 ROLLE 5 M

Parametry źródła światła | Light source parameters | Parameter der Lichtquelleto:

Indeks | Index | Index: R-2835-300-20-()-S1

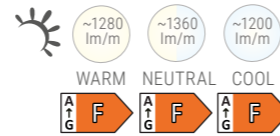

PREMIUM

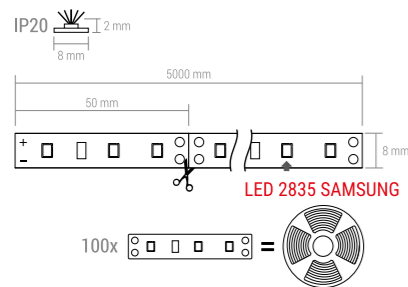

70. TAŚMA 120 LED/M PREMIUM Z DIODAMI SAMSUNG TYP 2835 BEZ ŻELU IP20 ROLKA 5 M | LED STRIP 120 LED/M PREMIUM WITH SAMSUNG DIODES TYPE 2835 WITHOUT GEL IP20 ROLL 5 M | LED STREIFEN 120 LED/M PREMIUM MIT SAMSUNG LEDS 2835 OHNE GEL IP20 ROLLE 5 M

Parametry źródła światła | Light source parameters | Parameter der Lichtquelleto:

Indeks | Index | Index: R-2835-600-20-()-S1

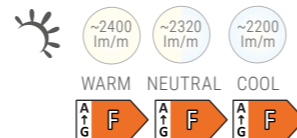

PREMIUM

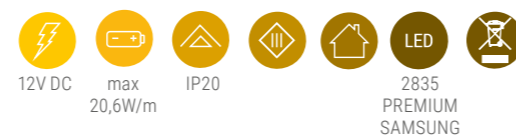
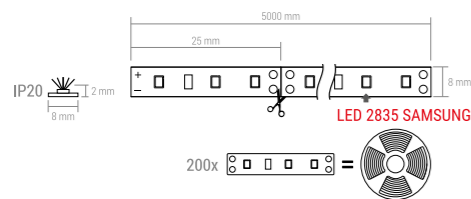

71. TAŚMA 60 LED/M PREMIUM Z DIODAMI SAMSUNG TYP 2835 BEZ ŻELU IP20 ROLKA 50 M | LED STRIP 60 LED/M PREMIUM WITH SAMSUNG DIODES TYPE 2835 WITHOUT GEL IP20 ROLL 50 M | LED STREIFEN 60 LED/M PREMIUM MIT SAMSUNG LEDS 2835 OHNE GEL IP20 ROLLE 50 M

Parametry źródła światła | Light source parameters | Parameter der Lichtquelleto:

Indeks | Index | Index: R-2835-50M-20-()-S1

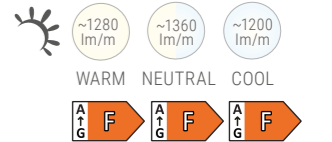

PREMIUM

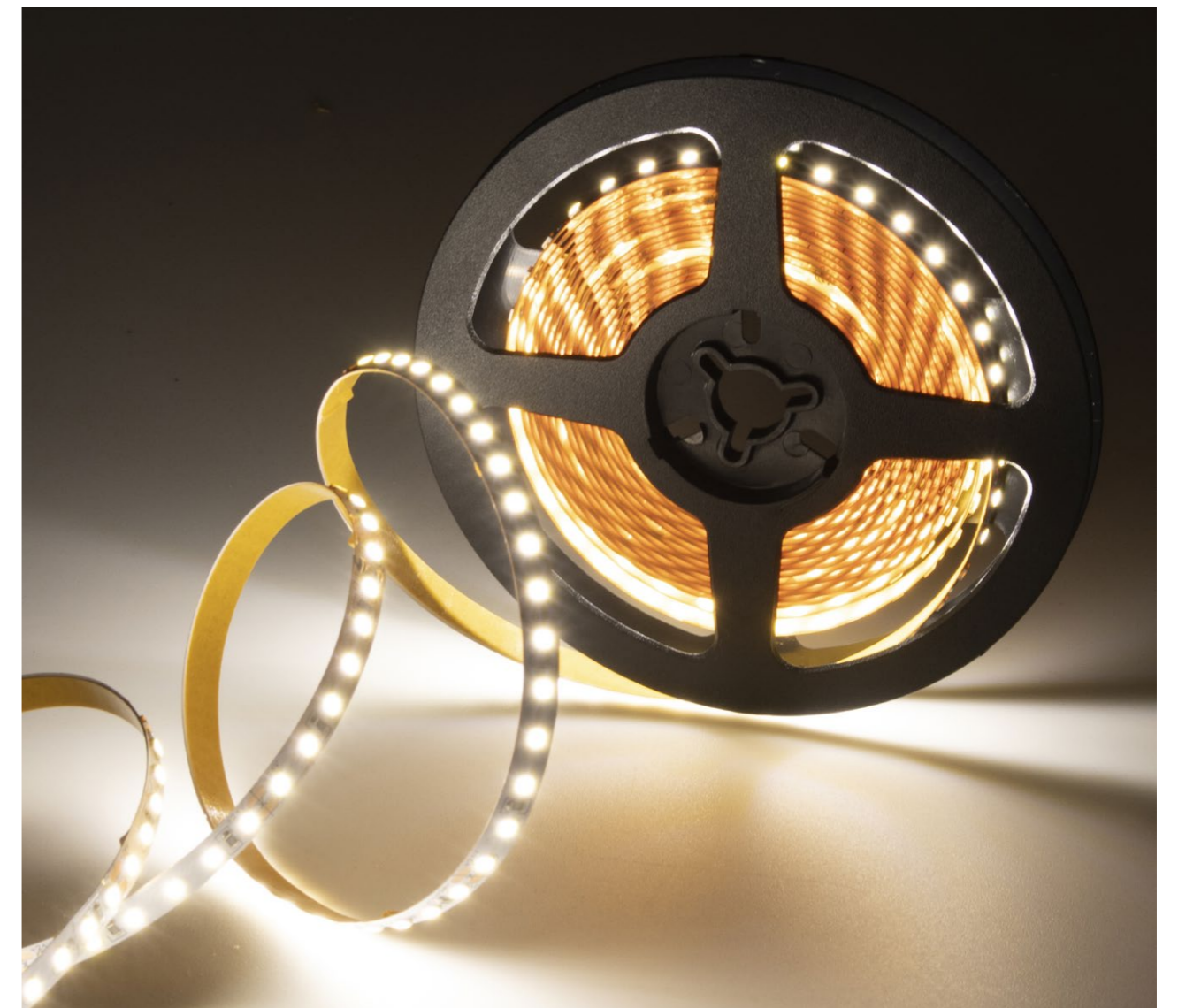
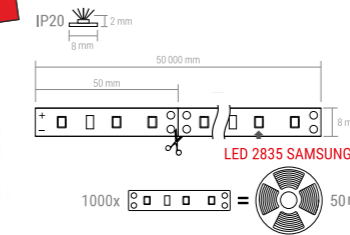
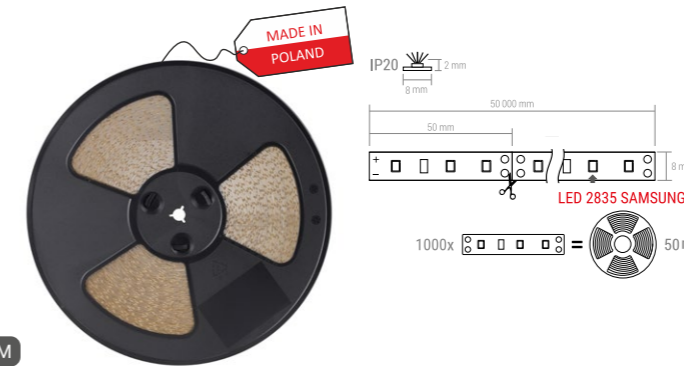

TAŚMY LED PRODUKCJI POLSKIEJ NA CZARNYM PODKŁADZIE PCB
| LED STRIPS ON BLACK PCB OF POLISH PRODUCTION | LED-STREIFEN DER POLNISCHEN
PRODUKTION AUF SCHWARZEM PCB

72. TAŚMA 60 LED/M PREMIUM TYP 2835 BEZ ŻELU IP20 ROLKA 5 M NA CZARNYM PODKŁADZIE PCB
| LED STRIP 60 LED/M PREMIUM TYPE 2835 WITHOUT GEL IP20 ROLL 5 M ON BLACK PCB | LED STREIFEN 60 LED/M PREMIUM 2835 OHNE GEL
IP20 ROLLE 5 M AUF SCHWARZEM PCB

Indeks | Index | Index: R-2835-300-20-()-03C

Parametry źródła światła | Light source parameters | Parameter der Lichtquelleto:

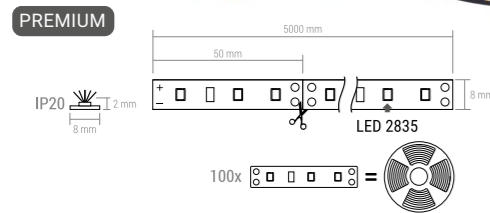
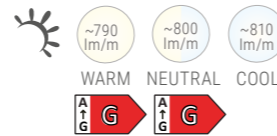

Zeskanuj kod smartfonem i zobacz film jak to działa.
 Scan QR code with a smartphone and watch a video of how it works.
 Scannen Sie den Code QR mit Ihrem Smartphone und sehen Sie sich das Video an, wie es funktioniert.

73. TAŚMA 120 LED/M PREMIUM TYP 2835 BEZ ŻELU IP20 ROLKA 5 M NA CZARNYM PODKŁADZIE PCB
| LED STRIP 120 LED/M PREMIUM TYPE 2835 WITHOUT GEL IP20 ROLL 5 M ON BLACK PCB | LED STREIFEN 120 LED/M PREMIUM 2835 OHNE GEL
IP20 ROLLE 5 M AUF SCHWARZEM PCB

Indeks | Index | Index: R-2835-600-20-()-03C

Parametry źródła światła | Light source parameters | Parameter der Lichtquelleto:

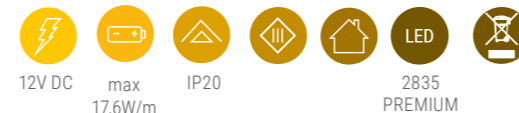
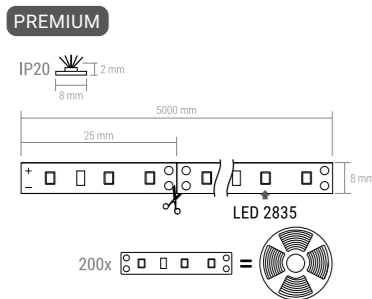
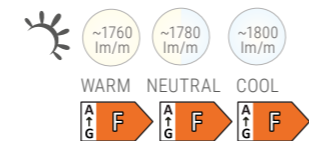

Zeskanuj kod smartfonem i zobacz film jak to działa.
 Scan QR code with a smartphone and watch a video of how it works.
 Scannen Sie den Code QR mit Ihrem Smartphone und sehen Sie sich das Video an, wie es funktioniert.

74. ZESTAW RF 30 LED/M RGB TAŚMA LED TYP 5050 W ŻELU IP45 LUB BEZ ŻELU IP20 | RF01 SET 30 LED/M
RGB TYPE 5050 IN GEL IP45 OR WITHOUT GEL IP20 | RF01 SET 30 LED/M RGB 5050 IN GEL IP45 ODER OHNE GEL IP20

IP45 Indeks | Index | Index: ZLF-RGB-5M-03W
 IP20 Indeks | Index | Index: ZLD-RGB-5M-03W

Parametry źródła światła | Light source parameters | Parameter der Lichtquelleto:

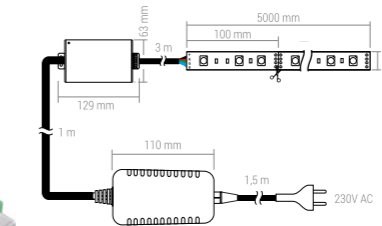

Osprzęt sterujący
 Control gear
 Betriebsgerät



75. ZESTAW RF 30 LED/M RGB TAŚMA LED TYP 5050 W ŻELU IP45 LUB BEZ ŻELU IP20 | RF02 SET 30 LED/M
RGB TYPE 5050 IN GEL IP45 OR WITHOUT GEL IP20 | RF02 SET 30 LED/M RGB 5050 IN GEL IP45 ODER OHNE GEL IP20

IP45 Indeks | Index | Index: ZLF-RGB-5M-02W
 IP20 Indeks | Index | Index: ZLD-RGB-5M-02W

Parametry źródła światła | Light source parameters | Parameter der Lichtquelleto:

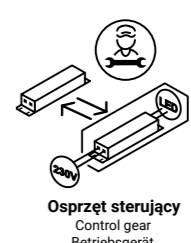
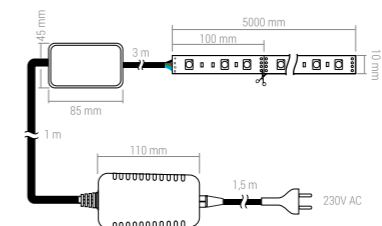

Osprzęt sterujący
 Control gear
 Betriebsgerät



76. ZESTAW IR 30 LED/M RGB TAŚMA LED TYP 5050 W ŻELU IP45 LUB BEZ ŻELU IP20 | IR SET 30 LED/M
RGB TYPE 5050 IN GEL IP45 OR WITHOUT GEL IP20 | IR SET 30 LED/M RGB 5050 IN GEL IP45 ODER OHNE GEL IP20

IP45 Indeks | Index | Index: ZLF-RGB-5M-01W
 IP20 Indeks | Index | Index: ZLD-RGB-5M-01W

Parametry źródła światła | Light source parameters | Parameter der Lichtquelleto:

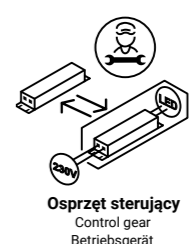
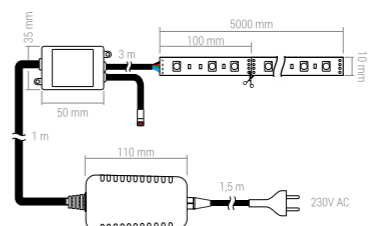

Osprzęt sterujący
 Control gear
 Betriebsgerät



77. ZESTAW TAŚMA 60 LED/M PREMIUM TYP 2835 BEZ ŻELU IP20 | SET 60 LED/M PREMIUM TYPE 2835 WITHOUT GEL IP20 | SET 60 LED/M PREMIUM TYP 2835 OHNE GEL

Indeks | Index | Index: T-2835-5M-300-(XC60)-XC-01W

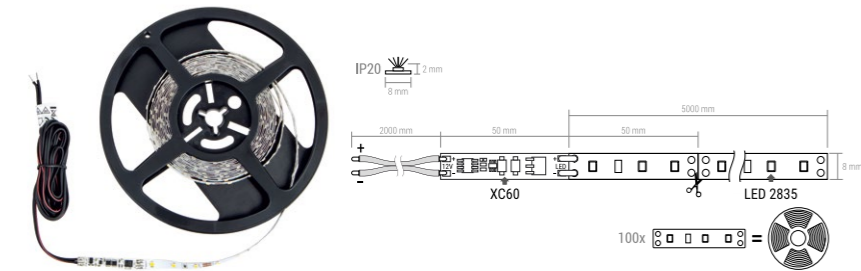

Zestaw zawiera 5 m rolkę taśmy LED typu Premium z przylutowanym wyłącznikiem XC60 z 2 m przewodem.

The set contains 5 m roll of Premium 30W LED strip with soldered XC60 switch. Set enthält ein 5 m Premium-Strip mit angeleitetem XC60 Schalter und 2 m Kabel.

Parametry źródła światła | Light source parameters | Parameter der Lichtquelleto:

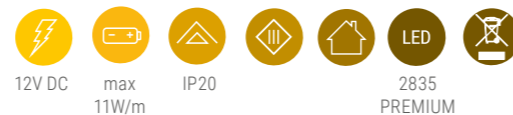
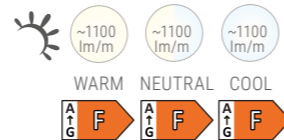

78. TAŚMA 480 LED/M TYP COB BEZ ŻELU IP20 | LED STRIP 480 LED/M TYPE COB WITHOUT GEL IP20 | LED STREIFEN 480 LED/M TYP COB OHNE GEL IP20

Indeks | Index | Index: R-COB-480-8-()-02

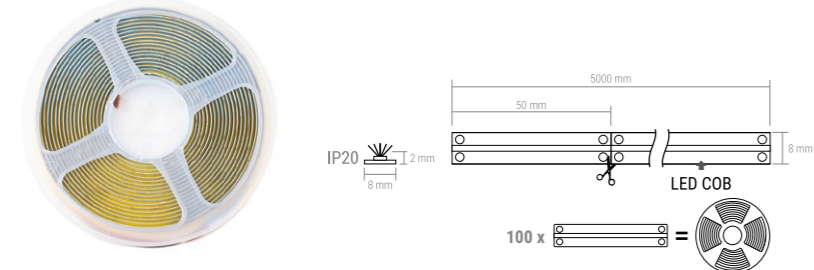

Zeskanuj kod smartfonem i zobacz film jak to działa. Scan QR code with a smartphone and watch a video of how it works. Scannen Sie den Code QR mit Ihrem Smartphone und sehen Sie sich das Video an, wie es funktioniert.

Parametry źródła światła | Light source parameters | Parameter der Lichtquelleto:

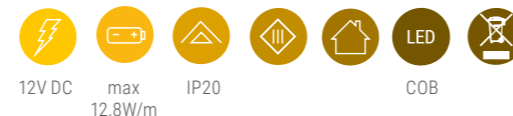
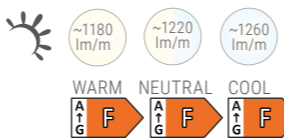

*UWAGA! Minimalny promień zagięcia taśmy wynosi R=12 mm. ATTENTION! The minimum bending radius of the strip is R=12 mm. ACHTUNG! Der minimale Biegeradius des Stripes beträgt R=12 mm.

79. TAŚMA 480 LED/M TYP COB BEZ ŻELU IP20 24V DC | LED STRIP 480 LED/M TYPE COB WITHOUT GEL IP20 24V DC | LED STREIFEN 480 LED/M TYP COB OHNE GEL IP20 24V DC

Indeks | Index | Index: R-24-COB-480-8-()-02

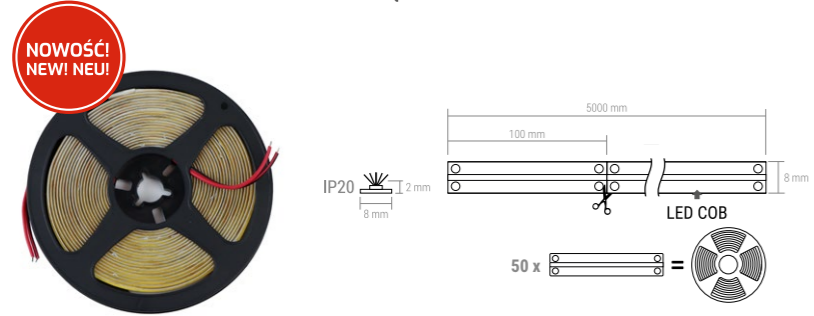

NOWOŚĆ! NEW! NEU!

Parametry źródła światła | Light source parameters | Parameter der Lichtquelleto:

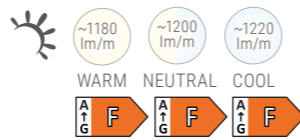

*UWAGA! Minimalny promień zagięcia taśmy wynosi R=12 mm. ATTENTION! The minimum bending radius of the strip is R=12 mm. ACHTUNG! Der minimale Biegeradius des Stripes beträgt R=12 mm.

80. TAŚMA 252 LED/M TYP COB RGB BEZ ŻELU IP20 | LED STRIP 252 LED/M TYPE COB RGB WITHOUT GEL IP20 | LED STREIFEN 252 LED/M TYP COB RGB OHNE GEL IP20

Indeks | Index | Index: R-COB-252-10-RGB-02

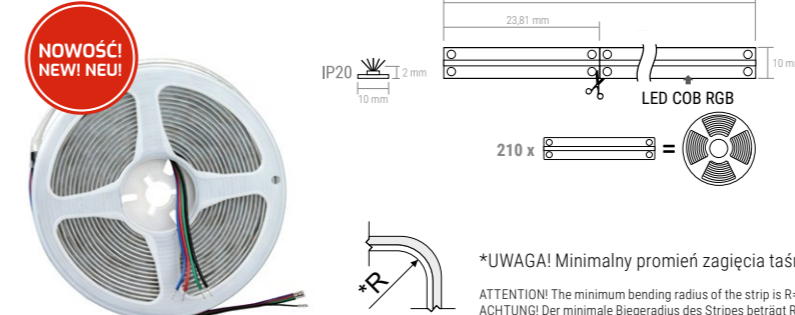

NOWOŚĆ! NEW! NEU!

Parametry źródła światła | Light source parameters | Parameter der Lichtquelleto:

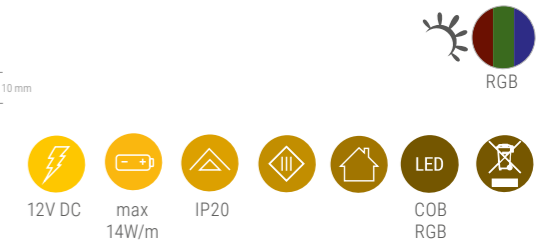

*UWAGA! Minimalny promień zagięcia taśmy wynosi R=12 mm. ATTENTION! The minimum bending radius of the strip is R=12 mm. ACHTUNG! Der minimale Biegeradius des Stripes beträgt R=12 mm.

81. TAŚMA 100 LED/M NEON FLEX TYP 2835 W SILIKONIE IP65 | NEON FLEX LED-STRIP 100 LED/M IN SILICONE IP65 | NEON FLEX LED-STRIP 100 LED/M IN SILIKON IP65

Indeks | Index | Index: N-6X12-Z-11W-()-01

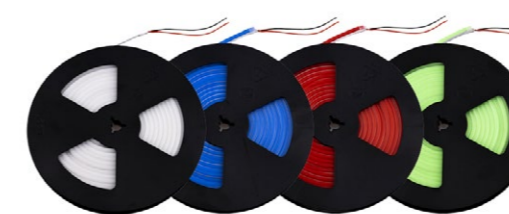

Parametry źródła światła | Light source parameters | Parameter der Lichtquelleto:

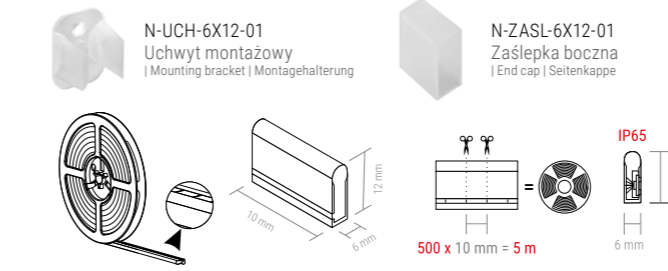
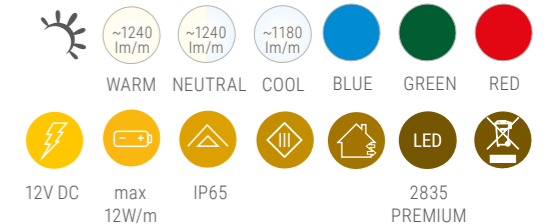

Produkt wyposażony. Containing product. Umgebendes Produkt. Ten produkt zawiera źródło światła o klasie efektywności energetycznej „F”. This product contains a light source of energy efficiency class „F”. Dieses Produkt enthält eine Lichtquelle der Energieeffizienzklasse „F”.

82. TAŚMA 100 LED/M NEON FLEX TYP 2835 W SILIKONIE IP65 24V DC | NEON FLEX LED-STRIP 100 LED/M IN SILICONE IP65 24V DC | NEON FLEX LED-STRIP 100 LED/M IN SILIKON IP65 24V DC

Indeks | Index | Index: N-24-6X12-Z-65-()-01

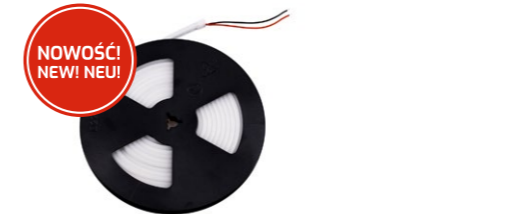

NOWOŚĆ! NEW! NEU!

Parametry źródła światła | Light source parameters | Parameter der Lichtquelleto:

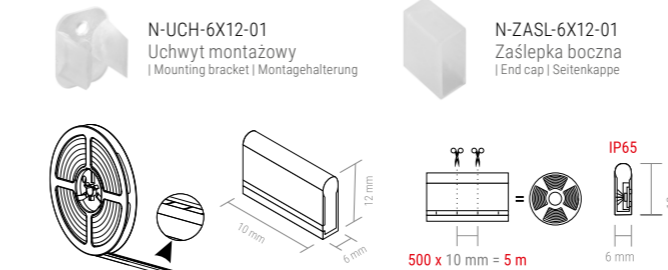

Produkt wyposażony. Containing product. Umgebendes Produkt. Ten produkt zawiera źródło światła o klasie efektywności energetycznej „F”. This product contains a light source of energy efficiency class „F”. Dieses Produkt enthält eine Lichtquelle der Energieeffizienzklasse „F”.

83. TAŚMA 64 LED/M FUTURE TYP 2835 BEZ ŻELU IP20 | LED STRIP 64 LED/M FUTURE TYPE 2835 WITHOUT GEL IP20 | LED STREIFEN 64 LED/M FUTURE TYP 2835 OHNE GEL

Indeks | Index | Index: R-2835-FUT-320-20-()-01

Parametry źródła światła | Light source parameters | Parameter der Lichtquelle:

~880 lm/m ~880 lm/m ~880 lm/m
WARM NEUTRAL COOL
A t G D A t G D A t G D

12V DC max 5,8W/m IP20 2835 PREMIUM

84. TAŚMA 112 LED/M FUTURE TYP 2835 BEZ ŻELU IP20 | LED STRIP 112 LED/M FUTURE TYPE 2835 WITHOUT GEL IP20 | LED STREIFEN 112 LED/M FUTURE TYP 2835 OHNE GEL

Indeks | Index | Index: R-2835-FUT-560-20-()-01

Parametry źródła światła | Light source parameters | Parameter der Lichtquelle:

~1560 lm/m ~1560 lm/m ~1560 lm/m
WARM NEUTRAL COOL
A t G D A t G D A t G D

12V DC max 10,2W/m IP20 2835 PREMIUM

85. TAŚMA 176 LED/M FUTURE TYP 2835 BEZ ŻELU IP20 | LED STRIP 176 LED/M FUTURE TYPE 2835 WITHOUT GEL IP20 | LED STREIFEN 176 LED/M FUTURE TYP 2835 OHNE GEL

Indeks | Index | Index: R-2835-FUT-880-20-()-01

Parametry źródła światła | Light source parameters | Parameter der Lichtquelle:

~2500 lm/m ~2500 lm/m ~2500 lm/m
WARM NEUTRAL COOL
A t G D A t G D A t G D

12V DC max 17W/m IP20 2835 PREMIUM

86. TAŚMA 60 LED/M 12V DC TYP 2835 BEZ ŻELU IP20 ROLKA 50 M | LED STRIP 60 LED/M 12V DC TYPE 2835 WITHOUT GEL IP20 ROLL 50 M | LED STREIFEN 60 LED/M 12V DC 2835 OHNE GEL IP20 ROLLE 50 M

Indeks | Index | Index: R-2835-50-060-20-()-2

Parametry źródła światła | Light source parameters | Parameter der Lichtquelle:

~1100 lm/m ~1100 lm/m ~1100 lm/m
WARM NEUTRAL COOL
A t G F A t G F A t G F

12V DC max 11W/m IP20 2835

Taśma LED w rolce 50 m to:
- łatwiejszy montaż,
- oszczędność czasu,
- zminimalizowanie strat materiałowych,
- możliwość cięcia taśmy na odcinki dowolnej długości.

The LED strip in roll 50 m:
- easier assemble,
- saving time,
- minimize material losses,
- ability to cut the tape to any length.

LED-Streifen in Rolle 50 m:
- einfachere Montage,
- Zeiteinsparung,
- Minimierung von Materialverlusten,
- Möglichkeit, den Streifen auf beliebige Länge zu schneiden.

Nie łączyć w odcinki dłuższe niż 5 metrów!

Do not connect in lengths longer than 5 m!

Abschnitte dürfen nicht länger als 5 m sein!

87. TAŚMA 120 LED/M 12V DC TYP 2835 BEZ ŻELU IP20 ROLKA 50 M | LED STRIP 120 LED/M 12V DC TYPE 2835 WITHOUT GEL IP20 ROLL 50 M | LED STREIFEN 120 LED/M 12V DC 2835 OHNE GEL IP20 ROLLE 50 M

Indeks | Index | Index: R-2835-50-120-20-()-2

Parametry źródła światła | Light source parameters | Parameter der Lichtquelle:

~1900 lm/m ~1900 lm/m ~1900 lm/m
WARM NEUTRAL COOL
A t G F A t G F A t G F

12V DC max 18W/m IP20 2835

Taśma LED w rolce 50 m to:
- łatwiejszy montaż,
- oszczędność czasu,
- zminimalizowanie strat materiałowych,
- możliwość cięcia taśmy na odcinki dowolnej długości.

The LED strip in roll 50 m:
- easier assemble,
- saving time,
- minimize material losses,
- ability to cut the tape to any length.

LED-Streifen in Rolle 50 m:
- einfachere Montage,
- Zeiteinsparung,
- Minimierung von Materialverlusten,
- Möglichkeit, den Streifen auf beliebige Länge zu schneiden.

Nie łączyć w odcinki dłuższe niż 5 metrów!

Do not connect in lengths longer than 5 m!

Abschnitte dürfen nicht länger als 5 m sein!

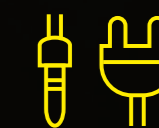
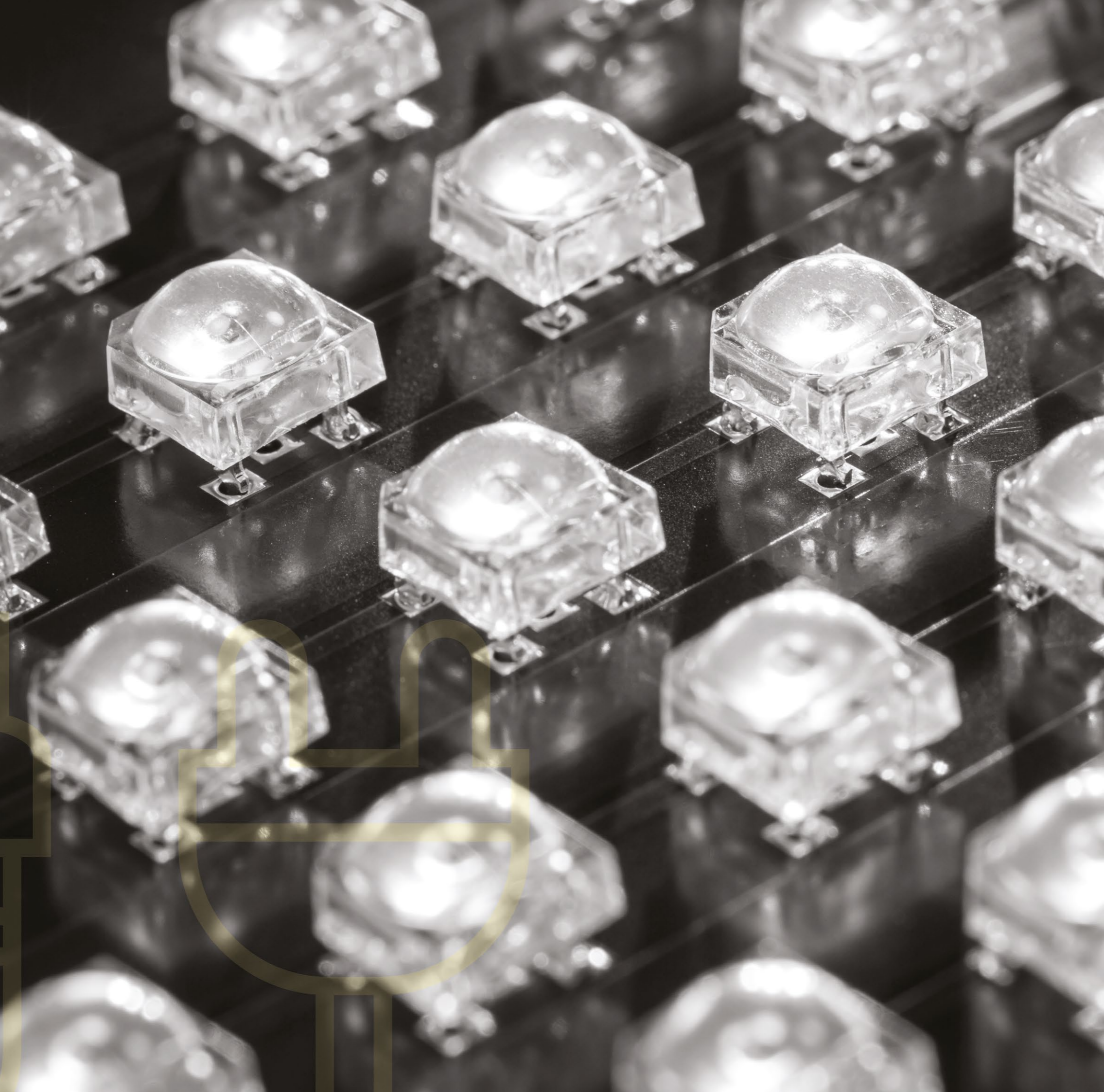

AKCESORIA DO LED

LED ACCESSORIES
LED ZUBEHÖR

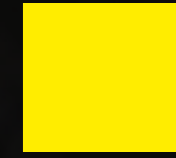

88. OKABLOWANIE DO TAŚM 8 MM I 10 MM MAX 2A | LED STRIPS CONNECTORS FOR 8 MM AND 10 MM MAX 2A | VERBINDER FÜR LED STREIFEN 8 MM UND 10 MM MAX 2A

ZŁĄCZKA MONTAŻOWA NA DWIE TAŚMY

ASSEMBLY CONNECTOR FOR TWO LED STRIPS
MONTAGEVERBINDER FÜR 2 LED STREIFEN



Indeks | Index | Index 8 mm: MO-LF08-BP-D1
Indeks | Index | Index: 10 mm: MO-LF10-BP-D1

PRZEWÓD MONTAŻOWY

ASSEMBLY CABLE
MONTAGEKABEL



Indeks | Index | Index 8 mm: MO-LF08-2M-D1
Indeks | Index | Index 10 mm: MO-LF10-2M-D1

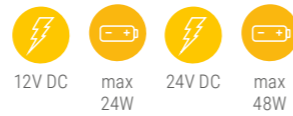

PRZEWÓD MONTAŻOWY Z WTYCZKĄ MINI

ASSEMBLY CABLE WITH MINI PLUG
MONTAGEKABEL MIT MINI-STECKER



Indeks | Index | Index 8 mm: MO-LF08-2M-D2

PRZEWÓD MONTAŻOWY NA DWIE TAŚMY

ASSEMBLY CABLE FOR TWO LED STRIPS
MONTAGEKABEL MIT MINI-STECKER FÜR 2 LED STREIFEN



Indeks | Index | Index 8 mm: MO-LF08-0,15M-D1

89. OKABLOWANIE DO TAŚM LED RGB 10 MM MAX 2A | LED RGB STRIPS CONNECTORS FOR 10 MM MAX 2A | VERBINDER VON LED RGB STREIFEN 10 MM MAX 2A

ZŁĄCZKA MONTAŻOWA NA DWIE TAŚMY LED RGB

ASSEMBLY CONNECTOR FOR TWO LED RGB STRIPS
MONTAGEVERBINDER FÜR ZWEI LED RGB STREIFEN



Indeks | Index | Index 10 mm: MO-LF10-BP-RGB-D1

PRZEWÓD MONTAŻOWY

ASSEMBLY CABLE
MONTAGEKABEL

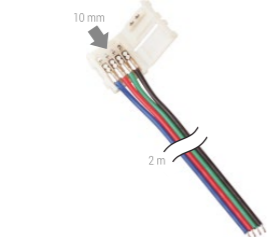

Indeks | Index | Index 10 mm: MO-LF10-2M-RGB-D1

90. ZŁĄCZKI DO TAŚM LED 8 MM MAX 3A | CONNECTORS FOR LED STRIPS 8 MM MAX 3A | STECKVERBINDER FÜR LED-BÄNDER 8 MM MAX 3A

Złączki do taśm LED idealnie mieszczą się w profilu LINE XL.

LED strip connector fits perfectly into LINE XL profile.
Schnellverbinder für LED Streifen passen perfekt in das LINE XL Profil.



1. Wymiary | Dimensions | Abmessungen
10,5 x 21 x 4,5 mm

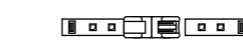

Indeks | Index | Index: MO-LF08-BP-D1M



1. Wymiary | Dimensions | Abmessungen
10,5 x 16 x 4,5 mm
2. Przewód | Cable | Kabel 15 cm, 2 x 0,50 mm²



Indeks | Index | Index: MO-LF08-0,15M-D1M



1. Wymiary | Dimensions | Abmessungen
10,5 x 16 x 4,5 mm
2. Przewód | Cable | Kabel 2 m, 2 x 0,50 mm²
3. Odcynowane końcówki | Tinned ends | Verzinnete Enden



Indeks | Index | Index: MO-LF08-2M-D1M



1. Wymiary | Dimensions | Abmessungen
10,5 x 16 x 4,5 mm
2. Przewód | Cable | Kabel 2 m, 2 x 0,30 mm²
3. Wtyczka Mini | Mini plug | Mini-Stecker

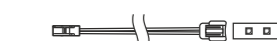

Indeks | Index | Index: MO-LF08-2M-D2M

91. ZŁĄCZKI KĄTOWE DO TAŚM LED 8 MM, 10 MM I LED RGB 10 MM MAX 2A | CORNER CONNECTORS FOR LED STRIPS 8 MM, 10 MM AND LED RGB 10 MM MAX 2A | ECK-SCHNELLVERBINDER FÜR LED STREIFEN 8 MM, 10 MM UND LED RGB 10 MM MAX 2A

ZŁĄCZKA KĄTOWA DO TAŚMY LED 8 MM

CORNER CONNECTOR FOR TWO LED STRIPS 8MM
ECK-SCHNELLVERBINDER FÜR LED 8MM

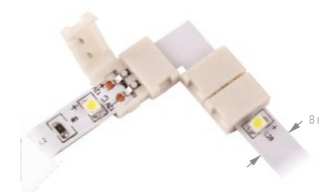

Indeks | Index | Index: MO-LF08-L-D1

ZŁĄCZKA KĄTOWA DO TAŚMY LED 10 MM

CORNER CONNECTOR FOR TWO LED STRIPS 10MM
ECK-SCHNELLVERBINDER FÜR LED 10MM

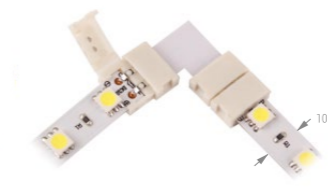

Indeks | Index | Index: MO-LF10-L-D1

ZŁĄCZKA KĄTOWA DO TAŚM LED RGB 10 MM

CORNER CONNECTOR FOR TWO LED RGB STRIPS 10MM
ECK-SCHNELLVERBINDER FÜR LED RGB STREIFEN 10MM



Indeks | Index | Index: MO-LF10-RGB-L-D1

PROSTY MONTAŻ TAŚMY LED W 3 KROKACH | EASY LED INSTALLATION IN 3 STEPS | EINFACHE LED-STREIFENMONTAGE IN 3 SCHRITTEN

1. Otwórz złączkę | Open the connector | Verbinder auf
2. Wsuń taśmę | Insert LED strip | Streifen einschieben
3. Zamknij złączkę | Close the connector | Verbinder zu

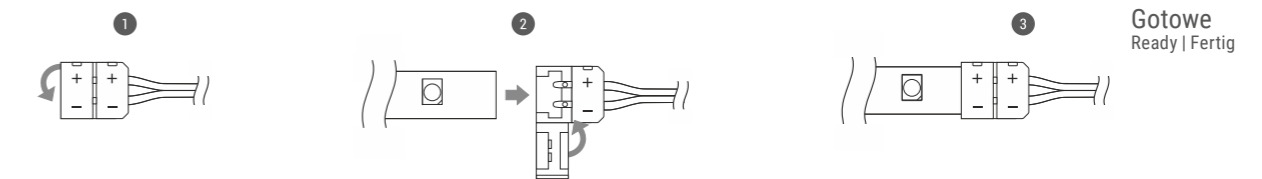

Uwaga! W przypadku taśmy IP45 należy usunąć żel w miejscu montażu złączki.

Notice! In the case of installation a LED strip with IP45, the protective gel must be removed at the installation side.
Achtung! Bei Streifen IP45 an der Stelle des verbindens Gel entfernen.

92. ROZDZIELACZ 6 PKT MINI | DIVIDER 6-PTS MINI | 6-FACHVERTEILER MINI



- 12V DC max 36W
- IP20
- 2 m

Indeks - Czarny | Index - Black | Index - Schwarz:
OKSZ-2M-LED-6-CZ-V02

Indeks - Biały | Index - White | Index - Weiß:
OKSZ-2M-LED-6-BI-V03

93. ROZDZIELACZ 3 PKT MINI | DIVIDER 3-PTS MINI | 3-FACHVERTEILER MINI



- 12V DC max 36W
- IP20
- 2 m

Indeks - Czarny | Index - Black | Index - Schwarz:
OKSZ-2M-LED-3-CZ

Indeks - Biały | Index - White | Index - Weiß:
OKSZ-2M-LED-3-BI

94. ROZDZIELACZ 6 PKT Z WTYCZKĄ MINI | DIVIDER 6-PTS WITH MINI PLUG | 6-FACHVERTEILER MIT MINI STECKER



- 12V DC max 36W
- IP20
- 2 m mini konektor
- 15 cm mini konektor

Indeks - Czarny | Index - Black | Index - Schwarz 2 m:
OKS-MIN6P-WTY-CZ-01

Indeks - Czarny | Index - Black | Index - Schwarz 15 cm:
OKS-MIN-6P-CZ

Indeks - Biały | Index - White | Index - Weiß:
OKS-MIN6P-WTY-BI-01

95. ROZDZIELACZ 3 PKT Z WTYCZKĄ MINI | DIVIDER 3-PTS WITH MINI PLUG | 3-FACHVERTEILER MIT MINI STECKER



- 12V DC max 36W
- IP20
- 2 m mini konektor
- 15 cm mini konektor

Indeks - Czarny | Index - Black | Index - Schwarz 2 m:
OKS-MIN3P-WTY-CZ-01

Indeks - Czarny | Index - Black | Index - Schwarz 15 cm:
OKS-MIN-3P-CZ

Indeks - Biały | Index - White | Index - Weiß:
OKS-MIN3P-WTY-BI-01

96. PRZEDŁUŻACZ DO OKABLOWANIA MINI | EXTENSION CABLE FOR MINI SYSTEM | VERLÄNGERUNGSKABEL FÜR DIE MINI VERKABELUNG

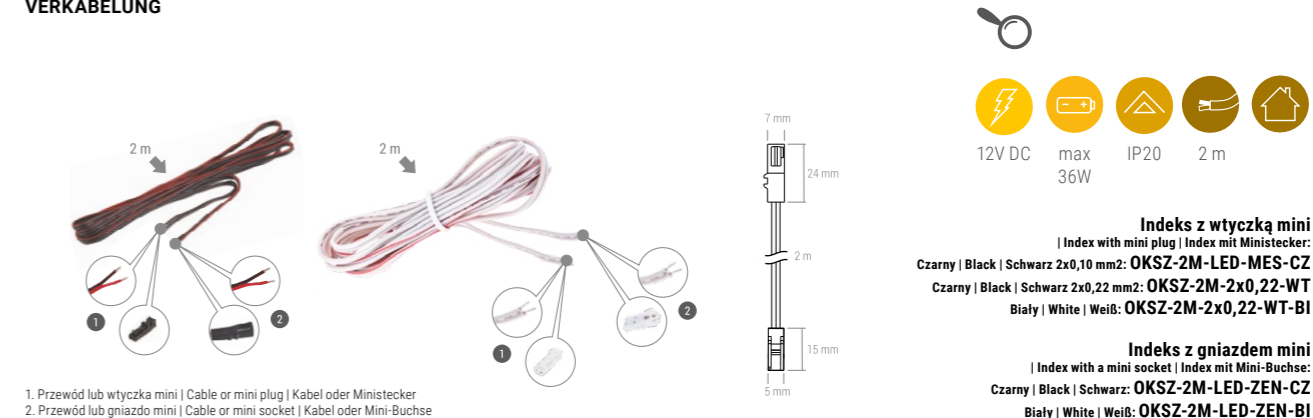

- 12V DC max 36W
- IP20
- 2 m

Indeks z wtyczką mini | Index with mini plug | Index mit Mini-Stecker:
Czarny | Black | Schwarz 2x0,10 mm2: OKSZ-2M-LED-MES-CZ
Czarny | Black | Schwarz 2x0,22 mm2: OKSZ-2M-2x0,22-WT
Biały | White | Weiß: OKSZ-2M-2x0,22-WT-BI

Indeks z gniazdem mini | Index with a mini socket | Index mit Mini-Buchse:
Czarny | Black | Schwarz: OKSZ-2M-LED-ZEN-CZ
Biały | White | Weiß: OKSZ-2M-LED-ZEN-BI

Indeks z wtyczką mini i gniazdem mini | Index with mini plug and mini socket | Index mit Mini-Stecker und Mini-Buchse:
Czarny | Black | Schwarz: OKZ-PRZ-2M/MIN/CZ
Biały | White | Weiß: OKZ-PRZ-2M/MIN/BI

PROSTY SYSTEM POŁĄCZEŃ: GNIAZDO-WTYCZKA MINI | SIMPLE CONNECTION SYSTEM: MINI-SOCKET | EINFACHES VERBINDUNGSSYSTEM: MINI-BÜCHSE

WTYCZKA MINI-KONEKTOR | MINI PLUG | MINI-STECKVERBINDER

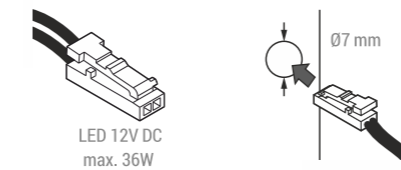

GNIAZDO MINI-KONEKTOR | MINI SOCKET | MINI-BÜCHSE

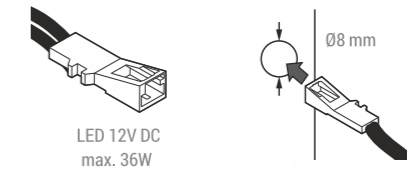

- ZASILANIE 12V DC | Power 12V DC | Leistung 12V DC
- OŚWIETLENIE | Light | Beleuchtung
- WYŁĄCZNIK | Switch | Schalter

97. MATA ANTYPOŚLIZGOWA | ANTI-SLIP MATE | RUTSCHFESTE MATTE



Niezbędne wyposażenie kuchennej szuflady

Necessary equipment for the kitchen drawer
Notwendige Küchenausstattung für Schubladen

Mata antypoślizgowa:
- ułatwia utrzymanie czystości w szufladach,
- chroni dno szuflady przed zarysowaniem,
- zapobiega przesuwaniu się przedmiotów,
- posiada estetyczny wygląd,
- jest łatwa w czyszczeniu.

Rutschfeste Matte:
- macht es einfach, die Schubladen sauber zu halten,
- schützt den Boden der Schublade vor Kratzern,
- verhindert, dass sich Gegenstände verschieben,
- hat ein ästhetisches Aussehen,
- ist leicht zu reinigen.

Non-slip mat:
- makes it easy to keep the drawers clean,
- protects the bottom of the drawer from scratching,
- prevents objects from moving,
- has an aesthetic appearance,
- is easy to clean.

L (mm)	H (mm)	W (mm)
20 000	1,2	500

Ilość w opakowaniu zbiorczym 20 mb

The quantity in a roll 20 mb | Die Menge in der Verpackung (rolle) 20 mb

Indeks | Index | Index: MA-P-500-()-01



PROFILE DO TAŚM LED

LED PROFILES
PROFILE FÜR LED
STREIFEN



98. PROFIL LINE 1 M, 2 M, 3 M ALUMINIUM | ALUMINIUM | ALUMINIUM



Pressed inside | Abdeckung zum Eindrücken

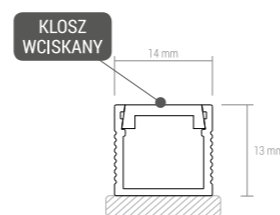

OP2-UCHWYT-PLS
Uchwyt montażowy
| Mounting bracket | Montagehalterung

	Klosz transparentny Transparent diffuser Transparent Abdeckung	Klosz mleczny Opal diffuser Opal Abdeckung	Zaślepka End cap Endkappe
1 m	PROFIL-LINE-TR-1M-W	PROFIL-LINE-OP-1M-W	OP2-ZASL-13x14-SZ-02
2 m	PROFIL-LINE-TR-2M-W	PROFIL-LINE-OP-2M-W	OP2-ZASL-13x14-SZ-02
3 m	PROFIL-LINE-TR-3M-W	PROFIL-LINE-OP-3M-W	OP2-ZASL-13x14-SZ-02

99. PROFIL LINE 2 M, 3 M BIAŁY, CZARNY | WHITE, BLACK | WEISS, SCHWARZ



Pressed inside | Abdeckung zum Eindrücken

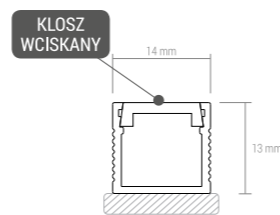

OP2-UCHWYT-PLS
Uchwyt montażowy
| Mounting bracket | Montagehalterung

	Klosz transparentny Transparent diffuser Transparent Abdeckung	Klosz mleczny Opal diffuser Opal Abdeckung	Zaślepka End cap Endkappe
2 m	PROFIL-LINE-TR-2M-B	PROFIL-LINE-OP-2M-B	OP2-ZASL-13x14-BI-02
2 m	PROFIL-LINE-TR-2M-C	PROFIL-LINE-OP-2M-C	OP2-ZASL-13x14-CZ-02
3 m	PROFIL-LINE-TR-3M-B	PROFIL-LINE-OP-3M-B	OP2-ZASL-13x14-BI-02
3 m	PROFIL-LINE-TR-3M-C	PROFIL-LINE-OP-3M-C	OP2-ZASL-13x14-CZ-02

100. PROFIL LINE MINI 1 M, 2 M, 3 M ALUMINIUM | ALUMINIUM | ALUMINIUM



Pressed inside | Abdeckung zum Eindrücken

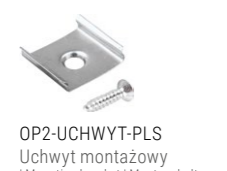
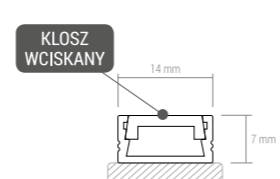

OP2-UCHWYT-PLS
Uchwyt montażowy
| Mounting bracket | Montagehalterung

	Klosz transparentny Transparent diffuser Transparent Abdeckung	Klosz mleczny Opal diffuser Opal Abdeckung	Zaślepka End cap Endkappe
1 m	PROFIL-LINEM-TR-1M-W	PROFIL-LINEM-OP-1M-W	OP2-ZASL-7X14-SZ-02
2 m	PROFIL-LINEM-TR-2M-W	PROFIL-LINEM-OP-2M-W	OP2-ZASL-7X14-SZ-02
3 m	PROFIL-LINEM-TR-3M-W	PROFIL-LINEM-OP-3M-W	OP2-ZASL-7X14-SZ-02

! Profil oferowany z kloszem, zaślepki i uchwyty dostępne osobno | Profile is available with diffuser, end caps and brackets are offered separately | Profile werden mit Abdeckung angeboten, Endkappen und Montagehalterung sind einzeln erhältlich

! WAŻNE! PROFILE OFEROWANE BEZ TAŚMY LED | PROFILES OFFERED WITHOUT LED STRIPS | PROFILE WERDEN OHNE LED STREIFEN ANGEBOten

! TOLERANCJA DŁUGOŚCI PROFILI I KLOSZY WYNOŚI +/- 2 MM | THE TOLERANCE OF THE LENGTH OF PROFILES AND DIFFUSERS IS +/- 2 MM | DIE TOLERANZ DER LÄNGE VON PROFILEN UND ABDECKUNGEN BETRÄGT +/- 2 MM

101. PROFIL LINE MINI 2 M BIAŁY, CZARNY, SZAMPAN, ŻŁOTY, 3 M BIAŁY, CZARNY, ŻŁOTY | WHITE, BLACK, CHAMPAGNE, GOLD | WEISS, SCHWARZ, CHAMPAGNER, GOLD



Pressed inside | Abdeckung zum Eindrücken

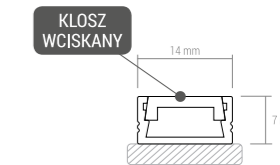

OP2-UCHWYT-PLS
Uchwyt montażowy
| Mounting bracket | Montagehalterung

		Klosz transparentny Transparent diffuser Transparent Abdeckung	Klosz mleczny Opal diffuser Opal Abdeckung	Klosz czarny Black diffuser Schwarz Abdeckung	Zaślepka End cap Endkappe
Biały White Weiß	2 m	PROFIL-LINEM-TR-2M-B	PROFIL-LINEM-OP-2M-B	PROFIL-LINEM-CZ-2M-B	OP2-ZASL-7X14-BI-02
	3 m	PROFIL-LINEM-TR-3M-B	PROFIL-LINEM-OP-3M-B	PROFIL-LINEM-CZ-3M-B	OP2-ZASL-7X14-BI-02
Czarny Black Schwarz	2 m	PROFIL-LINEM-TR-2M-C	PROFIL-LINEM-OP-2M-C	PROFIL-LINEM-CZ-2M-C	OP2-ZASL-7X14-CZ-02
	3 m	PROFIL-LINEM-TR-3M-C	PROFIL-LINEM-OP-3M-C	PROFIL-LINEM-CZ-3M-C	OP2-ZASL-7X14-CZ-02
Szampan Champagne Champagner	2 m	PROFIL-LINEM-TR-2M-I	PROFIL-LINEM-OP-2M-I	PROFIL-LINEM-CZ-2M-I	OP2-ZASL-7X14-IN
	3 m	PROFIL-LINEM-TR-3M-I	PROFIL-LINEM-OP-3M-I	PROFIL-LINEM-CZ-3M-I	OP2-ZASL-7X14-IN
Żłoty Gold Gold	2 m	PROFIL-LINEM-TR-2M-ZL	PROFIL-LINEM-OP-2M-ZL	PROFIL-LINEM-CZ-2M-ZL	OP2-ZASL-7X14-ZL-02
	3 m	PROFIL-LINEM-TR-3M-ZL	PROFIL-LINEM-OP-3M-ZL	PROFIL-LINEM-CZ-3M-ZL	OP2-ZASL-7X14-ZL-02

102. PROFIL LINE MICRO 2 M, 3 M ALUMINIUM | ALUMINIUM | ALUMINIUM



Pressed inside | Abdeckung zum Eindrücken

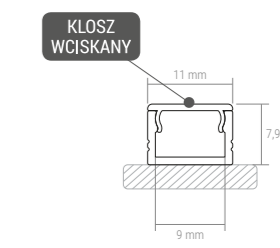

OP2-UCHWYT-PLS
Uchwyt montażowy
| Mounting bracket | Montagehalterung

		Klosz transparentny Transparent diffuser Transparent Abdeckung	Klosz mleczny Opal diffuser Opal Abdeckung	Zaślepka End cap Endkappe
2 m	PROF-LMICRO-AL-TR-2M	PROF-LMICRO-AL-OP-2M	OP2-ZASL-LMICRO-SZ-02	
3 m	PROF-LMICRO-AL-TR-3M	PROF-LMICRO-AL-OP-3M	OP2-ZASL-LMICRO-SZ-02	

103. PROFIL LINE XL 1 M, 2 M, 3 M ALUMINIUM | ALUMINIUM | ALUMINIUM



Pressed inside | Abdeckung zum Eindrücken

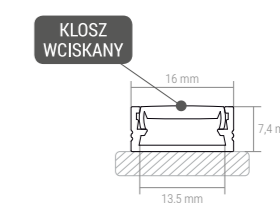

OP2-UCH-LINEXL-01
Uchwyt montażowy
| Mounting bracket | Montagehalterung

		Klosz transparentny Transparent diffuser Transparent Abdeckung	Klosz mleczny Opal diffuser Opal Abdeckung	Zaślepka End cap Endkappe
1 m	PROF-LINEXL-TR-1M-W	PROF-LINEXL-OP-1M-W	OP2-ZASL-7X16-SZ	
2 m	PROF-LINEXL-TR-2M-W	PROF-LINEXL-OP-2M-W	OP2-ZASL-7X16-SZ	
3 m	PROF-LINEXL-TR-3M-W	PROF-LINEXL-OP-3M-W	OP2-ZASL-7X16-SZ	

! Profil oferowany z kloszem, zaślepki i uchwyty dostępne osobno | Profile is available with diffuser, end caps and brackets are offered separately | Profile werden mit Abdeckung angeboten, Endkappen und Montagehalterung sind einzeln erhältlich

! WAŻNE! PROFILE OFEROWANE BEZ TAŚMY LED | PROFILES OFFERED WITHOUT LED STRIPS | PROFILE WERDEN OHNE LED STREIFEN ANGEBOten

! TOLERANCJA DŁUGOŚCI PROFILI I KLOSZY WYNOŚI +/- 2 MM | THE TOLERANCE OF THE LENGTH OF PROFILES AND DIFFUSERS IS +/- 2 MM | DIE TOLERANZ DER LÄNGE VON PROFILEN UND ABDECKUNGEN BETRÄGT +/- 2 MM

104. PROFIL TRI-LINE 2 M ALUMINIUM | ALUMINIUM | ALUMINIUM

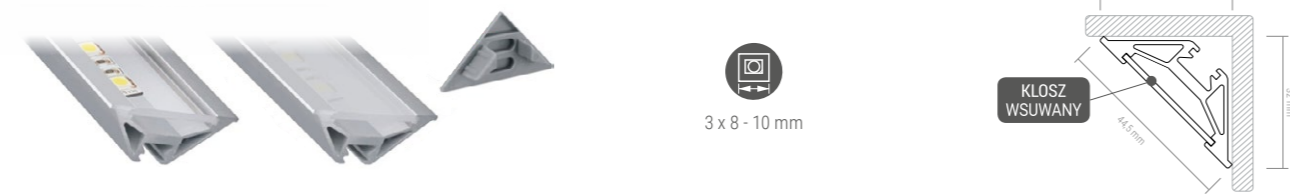

	Klosz transparentny Transparent diffuser Transparent Abdeckung	Klosz mleczny Opal diffuser Opal Abdeckung	Zaślepka End cap Endkappe
2 m	PROF-3LIN-TR-2W	PROF-3LIN-OP-2W	OP2-ZASL-STAR-SZ

105. PROFIL TRI-LINE MINI 1 M, 2 M, 3 M ALUMINIUM | ALUMINIUM | ALUMINIUM



	Klosz transparentny Transparent diffuser Transparent Abdeckung	Klosz mleczny Opal diffuser Opal Abdeckung	Zaślepka L End cap L Endkappe L	Zaślepka P End cap P Endkappe P
1 m	PROFIL-MN-3LIN-TR-1W	PROFIL-MN-3LIN-ML-1W	OP2-ZASL-L-SM	OP2-ZASL-P-SM
2 m	PROFIL-MN-3LM-TR-2W	PROFIL-MN-3LM-ML-2W	OP2-ZASL-L-SM	OP2-ZASL-P-SM
3 m	PROFIL-MN-3LIN-TR-3W	PROFIL-MN-3LIN-ML-3W	OP2-ZASL-L-SM	OP2-ZASL-P-SM

106. PROFIL TRI-LINE MINI 2 M BIAŁY, CZARNY, SZAMPAN, ŻŁOTY, 3 M BIAŁY, CZARNY, ŻŁOTY | WHITE, BLACK, CHAMPAGNE, GOLD | WEISS, SCHWARZ, CHAMPAGNER, GOLD



	Klosz transparentny Transparent diffuser Transparent Abdeckung	Klosz mleczny Opal diffuser Opal Abdeckung	Klosz czarny Black diffuser Schwarz Abdeckung	Zaślepka End cap Endkappe
Biały White Weiß	2 m	PROFIL-MN-3LM-TR-2B	PROFIL-MN-3LM-ML-2B	OP2-ZASL-P-SM-BI OP2-ZASL-L-SM-BI
	3 m	PROFIL-MN-3LIN-TR-3B	PROFIL-MN-3LIN-ML-3B	OP2-ZASL-P-SM-BI OP2-ZASL-L-SM-BI
Czarny Black Schwarz	2 m	PROFIL-MN-3LIN-TR-2C	PROFIL-MN-3LIN-ML-2C	OP2-ZASL-P-SM-CZ OP2-ZASL-L-SM-CZ
	3 m	PROFIL-MN-3LIN-TR-3CZ	PROFIL-MN-3LIN-ML-3CZ	OP2-ZASL-P-SM-CZ OP2-ZASL-L-SM-CZ
Szampań Champagne Champagner	2 m	PROFIL-MN-3LM-TR-2IN	PROFIL-MN-3LM-ML-2IN	OP2-ZASL-P-SM-IN OP2-ZASL-L-SM-IN
Żłoty Gold Gold	2 m	PROFIL-MN-3LM-ML-2ZL	PROFIL-MN-3LM-ML-2ZL	OP2-ZASL-P-SM-ZL OP2-ZASL-L-SM-ZL
	3 m	PROFIL-MN-3LM-ML-3ZL	PROFIL-MN-3LM-ML-3ZL	OP2-ZASL-P-SM-ZL OP2-ZASL-L-SM-ZL

107. PROFIL NEOLINE 2 M, 3 M ALUMINIUM | ALUMINIUM | ALUMINIUM



	Klosz transparentny + transparentny Transparent + transparent diffuser Transparent + Transparent Abdeckung	Klosz mleczny + transparentny Opal + transparent diffuser Opal + Transparent Abdeckung	Klosz mleczny + mleczny Opal + opal diffuser Opal + Opal Abdeckung	Zaślepka L End cap L Endkappe L	Zaślepka P End cap P Endkappe P
2 m	PROF-NEO-TR-TR-AL-2M-1W	PROF-NEO-OP-TR-AL-2M-1W	PROF-NEO-OP-OP-AL-2M-1W	OP2-ZASL-NEO-SZ-L-01	OP2-ZASL-NEO-SZ-P-01
3 m	PROF-NEO-TR-TR-AL-3M-1W	PROF-NEO-OP-TR-AL-3M-1W	PROF-NEO-OP-OP-AL-3M-1W	OP2-ZASL-NEO-SZ-L-01	OP2-ZASL-NEO-SZ-P-01

108. PROFIL CORNER LINE 1 M, 2 M, 3 M ALUMINIUM | ALUMINIUM | ALUMINIUM



Sposób montażu:
Mounting method:
Montageart:

- Montaż uchwytem do wieńca dolnego z otworem
| 1. Installation with a mounting holders to the bottom panel
| 1. Befestigung mittels einer Halterung an der Bodenplatte
- Montaż na taśmie dwustronnej
| 2. Mounting on double-sided tape
| 2. Montage auf doppelseitigem Klebeband
- Montaż wkrętem do wieńca dolnego z otworem
| 3. Mounting with a screw to the bottom panel
| 3. Befestigung mit einer Schraube an der Bodenplatte

	Klosz mleczny Opal diffuser Opal Abdeckung	Zaślepka End cap Endkappe	Zaślepka z otworem End cap with hole Endkappe mit Loch
1 m	PROFIL-CORNERLINE-OP-1W	OP2-ZASL-COR-SZ-01	OP2-ZASL-COR-O-SZ-01
2 m	PROFIL-CORNERLINE-OP-2W	OP2-ZASL-COR-SZ-01	OP2-ZASL-COR-O-SZ-01
3 m	PROFIL-CORNERLINE-OP-3W	OP2-ZASL-COR-SZ-01	OP2-ZASL-COR-O-SZ-01

109. PROFIL SKYLINE WPUSZCZANY 2 M, 3 M ALUMINIUM | ALUMINIUM | ALUMINIUM

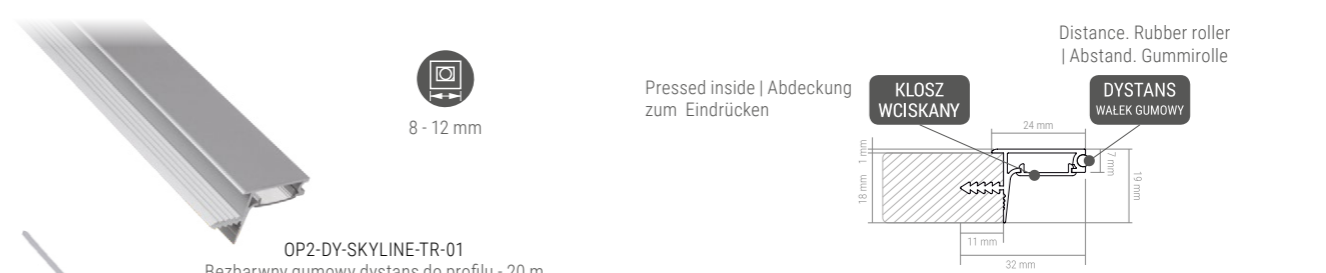

OP2-DY-SKYLINE-TR-01
Bezbarwny gumowy dystans do profilu - 20 m
| Transparent rubber distance to the profile - 20 m
| Farbloser Gummiaabstand fürs Profil - 20 m

OP2-DY-SKYLINE-TR-2M-01
Bezbarwny gumowy dystans do profilu - 2 m
| Transparent rubber distance to the profile - 2 m
| Farbloser Gummiaabstand fürs Profil - 2 m

	Klosz transparentny Transparent diffuser Transparent Abdeckung	Klosz mleczny Opal diffuser Opal Abdeckung
2 m	PROFIL-SKYLINE-TR-2M-W	PROFIL-SKYLINE-OP-2M-W
3 m	PROFIL-SKYLINE-TR-3M-W	PROFIL-SKYLINE-OP-3M-W

- ! Profil oferowany z kloszem, zaślepkami i uchwyty dostępne osobno | Profile is available with diffuser, end caps and brackets are offered separately | Profile werden mit Abdeckung angeboten, Endkappen und Montagehalterung sind einzeln erhältlich
- ! WAŻNE! PROFILE OFEROWANE BEZ TAŚMY LED | PROFILES OFFERED WITHOUT LED STRIPS | PROFILE WERDEN OHNE LED STREIFEN ANGEBOten
- ! TOLERANCJA DŁUGOŚCI PROFILI I KLOSZY WYNOŚI +/- 2 MM | THE TOLERANCE OF THE LENGTH OF PROFILES AND DIFFUSERS IS +/- 2 MM | DIE TOLERANZ DER LÄNGE VON PROFILEN UND ABDECKUNGEN BETRÄGT +/- 2 MM

- ! Profil oferowany z kloszem, zaślepkami i uchwyty dostępne osobno | Profile is available with diffuser, end caps and brackets are offered separately | Profile werden mit Abdeckung angeboten, Endkappen und Montagehalterung sind einzeln erhältlich
- ! WAŻNE! PROFILE OFEROWANE BEZ TAŚMY LED | PROFILES OFFERED WITHOUT LED STRIPS | PROFILE WERDEN OHNE LED STREIFEN ANGEBOten
- ! TOLERANCJA DŁUGOŚCI PROFILI I KLOSZY WYNOŚI +/- 2 MM | THE TOLERANCE OF THE LENGTH OF PROFILES AND DIFFUSERS IS +/- 2 MM | DIE TOLERANZ DER LÄNGE VON PROFILEN UND ABDECKUNGEN BETRÄGT +/- 2 MM

110. PROFIL SKYLINE NAKŁADANY 2 M, 3 M ALUMINIUM | ALUMINIUM | ALUMINIUM



Pressed inside | Abdeckung zum Eindrücken

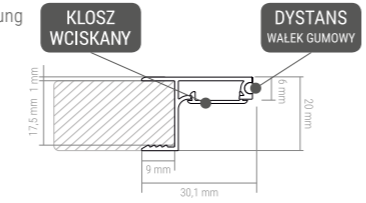

	Kłoz transparentny Transparent diffuser Transparent Abdeckung	Kłoz mleczny Opal diffuser Opal Abdeckung
2 m	PROFIL-SKYLINE-N-TR-2M-W	PROFIL-SKYLINE-N-OP-2M-W
3 m	PROFIL-SKYLINE-N-TR-3M-W	PROFIL-SKYLINE-N-OP-3M-W

INIUM | ALUMINIUM | ALUMINIUM

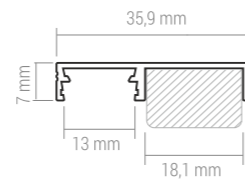

Zeskanuj kod smartfonem i zobacz film jak to działa.
Scan QR code with a smartphone and watch a video of how it works.
Scannen Sie den Code QR mit Ihrem Smartphone und sehen Sie sich das Video an, wie es funktioniert.

	Kłoz transparentny Transparent diffuser Transparent Abdeckung	Kłoz mleczny Opal diffuser Opal Abdeckung
2 m	PROFIL-FLOORLINE-TR-2M-W	PROFIL-FLOORLINE-OP-2M-W
3 m	PROFIL-FLOORLINE-TR-3M-W	PROFIL-FLOORLINE-OP-3M-W

111. RELING - DRAŻEK OKRĄGŁY LED 2 M, 3 M ALUMINIUM, CZARNY | RAILING WITH CIRCULAR BAR 2 M, 3 M ALUMINIUM, BLACK | LED KLEIDERSTANGENPROFIL RELING 2 M, 3M ALUMINIUM, SCHWARZ



Pressed inside | Abdeckung zum Eindrücken

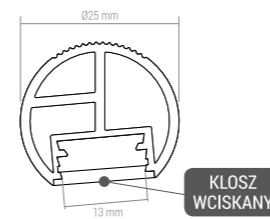

	Kłoz transparentny Transparent diffuser Transparent Abdeckung	Kłoz mleczny Opal diffuser Opal Abdeckung
2 m	PROF-REL-TR-2W	PROF-REL-OP-2W
3 m	PROF-REL-TR-3W	PROF-REL-OP-3W
2 m	PROF-REL-TR-2C	PROF-REL-OP-2C
3 m	PROF-REL-TR-3C	PROF-REL-OP-3C

Profil oferowany z kłozem, zaślepki i uchwyty dostępne osobno | Profile is available with diffuser, end caps and brackets are offered separately | Profile werden mit Abdeckung angeboten, Endkappen und Montagehalterung sind einzeln erhältlich

WAŻNE! PROFILE OFEROWANE BEZ TAŚMY LED | PROFILES OFFERED WITHOUT LED STRIPS | PROFILE WERDEN OHNE LED STREIFEN ANGEBOTEN

TOLERANCJA DŁUGOŚCI PROFILI I KŁOSZY WYNOŚI +/- 2 MM | THE TOLERANCE OF THE LENGTH OF PROFILES AND DIFFUSERS IS +/- 2 MM | DIE TOLERANZ DER LÄNGE VON PROFILN UND ABDECKUNGEN BETRÄGT +/- 2 MM

112. ROZETA - UCHWYT Z TWORZYWA SZTUCZNEGO DO DRAŻKA LED | ROSETTE - PLASTIC HOLDER FOR LED BAR | ROSETTE - HALTERUNG AUS KUNSTSTOFF FÜR LED-RELING PROFIL

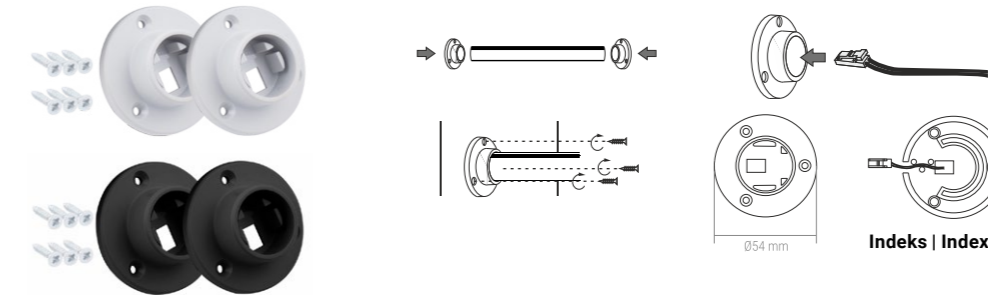

Zabezpieczenie przewodu przed wyrwaniem.
| Cable protection against pulling out.
| Kabelschutz vor dem Ausreißen.

Indeks | Index | Index GREY: OP2-UCH-REL-SZ-01W
BLACK: OP2-UCH-REL-CZ-01W

113. PROFIL RELING SLIM 2 M, 3 M BIAŁY, ALUMINIUM, CZARNY | BIAŁY, ALUMINIUM, BLACK | WEISS, ALUMINIUM, SCHWARZ

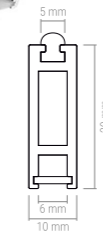

		Kłoz mleczny Opal diffuser Opal Abdeckung
Aluminium Aluminium Aluminium	2 m	PROF-REL-S-AL-OP-2M
	3 m	PROF-REL-S-AL-OP-3M
Biały White Weiß	2 m	PROF-REL-S-BI-OP-2M
	3 m	PROF-REL-S-BI-OP-3M
Czarny Black Schwarz	2 m	PROF-REL-S-CZ-OP-2M
	3 m	PROF-REL-S-CZ-OP-3M

Profil oferowany bez uchwytów montażowych.
| Profile offered without mounting brackets.
| Das Profil angeboten ohne Montagehalterungsset.

114. UCHWYTY Z WKRĘTAMI DO RELING SLIM | MOUNTING BRACKETS FOR THE RELING SLIM PROFILE | MONTAGEHALTERUNGS FÜR DAS RELING SLIM PROFIL



Tworzywo ABS
| ABS plastic | ABS-Kunststoff | ABS-пластик

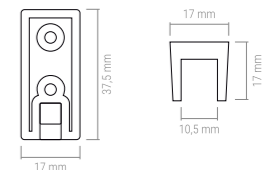

Indeks | Index | Index WHITE: OP2-UCH-REL-S-BI-01W
GRAY: OP2-UCH-REL-S-SZ-01W
BLACK: OP2-UCH-REL-S-CZ-01W

115. PROFIL INLINE 1 M, 2 M ALUMINIUM | ALUMINIUM | ALUMINIUM

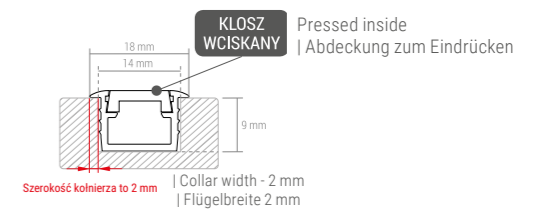

	Kłoz transparentny Transparent diffuser Transparent Abdeckung	Kłoz mleczny Opal diffuser Opal Abdeckung	Zaślepka End cap Endkappe
1 m	PROF-INLINE-TR-1M-W	PROF-INLINE-OP-1M-W	OP2-ZASL-INLINE-SZ-01
2 m	PROF-INLINE-TR-2M-W	PROF-INLINE-OP-2M-W	OP2-ZASL-INLINE-SZ-01

Profil oferowany z kłozem, zaślepki i uchwyty dostępne osobno | Profile is available with diffuser, end caps and brackets are offered separately | Profile werden mit Abdeckung angeboten, Endkappen und Montagehalterung sind einzeln erhältlich

WAŻNE! PROFILE OFEROWANE BEZ TAŚMY LED | PROFILES OFFERED WITHOUT LED STRIPS | PROFILE WERDEN OHNE LED STREIFEN ANGEBOTEN

TOLERANCJA DŁUGOŚCI PROFILI I KŁOSZY WYNOŚI +/- 2 MM | THE TOLERANCE OF THE LENGTH OF PROFILES AND DIFFUSERS IS +/- 2 MM | DIE TOLERANZ DER LÄNGE VON PROFILN UND ABDECKUNGEN BETRÄGT +/- 2 MM

116. PROFIL INLINE MINI 1 M, 2 M, 3 M BIAŁY, CZARNY, ALUMINIUM | WHITE, BLACK, ALUMINIUM | WEISS, SCHWARZ, ALUMINIUM

		Klosz transparentny Transparent diffuser Transparent Abdeckung	Klosz mleczny Opal diffuser Opal Abdeckung	Zaślepka End cap Endkappe
Aluminium Aluminium Aluminium	1 m	PROF-INLINEM-TR-1M-W	PROF-INLINEM-OP-1M-W	OP2-ZASL-INM-M-SZ-01
	2 m	PROF-INLINEM-TR-2M-W	PROF-INLINEM-OP-2M-W	
	3 m	PROF-INLINEM-TR-3M-W	PROF-INLINEM-OP-3M-W	
Biały White Weiß	2 m	PROF-INLINEM-OP-2M-B	PROF-INLINEM-TR-2M-B	OP2-ZASL-WP-BI-V1
Czarny Black Schwarz	2 m	PROF-INLINEM-OP-2M-C	PROF-INLINEM-TR-2M-C	OP2-ZASL-WP-CZ-V1

117. PROFIL INLINE MINI XL 2 M, 3 M BIAŁY, CZARNY, ALUMINIUM, ŻŁOTY | WHITE, BLACK, ALUMINIUM, GOLD | WEISS, SCHWARZ, ALUMINIUM, GOLD

		Klosz transparentny Transparent diffuser Transparent Abdeckung	Klosz mleczny Opal diffuser Opal Abdeckung	Klosz czarny Black diffuser Schwarz Abdeckung	Zaślepka End cap Endkappe
Biały White Weiß	2 m	PROF-INLINEM-XL-TR-2M-B	PROF-INLINEM-XL-OP-2M-B	PROF-INLINEM-XL-CZ-2M-B	OP2-ZASL-INM-XL-BI-01
	3 m	PROF-INLINEM-XL-TR-3M-B	PROF-INLINEM-XL-OP-3M-B	PROF-INLINEM-XL-CZ-3M-B	
Czarny Black Schwarz	2 m	PROF-INLINEM-XL-TR-2M-C	PROF-INLINEM-XL-OP-2M-C	PROF-INLINEM-XL-CZ-2M-C	OP2-ZASL-INM-XL-CZ-01
	3 m	PROF-INLINEM-XL-TR-3M-C	PROF-INLINEM-XL-OP-3M-C	PROF-INLINEM-XL-CZ-3M-C	
Aluminium Aluminium Aluminium	2 m	PROF-INLINEM-XL-TR-2M-W	PROF-INLINEM-XL-OP-2M-W	PROF-INLINEM-XL-CZ-2M-W	OP2-ZASL-INM-XL-SZ-01
	3 m	PROF-INLINEM-XL-TR-3M-W	PROF-INLINEM-XL-OP-3M-W	PROF-INLINEM-XL-CZ-3M-W	
Złoty Gold Gold	2 m	PROF-INLINEM-XL-TR-2M-ZL	PROF-INLINEM-XL-OP-2M-ZL	PROF-INLINEM-XL-CZ-2M-ZL	OP2-ZASL-INM-XL-ZL-01
	3 m	PROF-INLINEM-XL-TR-3M-ZL	PROF-INLINEM-XL-OP-3M-ZL	PROF-INLINEM-XL-CZ-3M-ZL	

! Profil oferowany z kloszem, zaślepki i uchwyty dostępne osobno | Profile is available with diffuser, end caps and brackets are offered separately | Profile werden mit Abdeckung angeboten, Endkappen und Montagehalterung sind einzeln erhältlich

! **WAŻNE! PROFILE OFEROWANE BEZ TAŚMY LED** | PROFILES OFFERED WITHOUT LED STRIPS | PROFILE WERDEN OHNE LED STREIFEN ANGEBOten

! **TOLERANCJA DŁUGOŚCI PROFILI I KŁOSZY WYNOŚI +/- 2 MM** | THE TOLERANCE OF THE LENGTH OF PROFILES AND DIFFUSERS IS +/- 2 MM | DIE TOLERANZ DER LÄNGE VON PROFILEN UND ABDECKUNGEN BETRÄGT +/- 2 MM

118. PROFIL INLINE Z 2 M ALUMINIUM, BIAŁY, CZARNY, 3 M ALUMINIUM | WHITE, BLACK, ALUMINIUM | WEISS, SCHWARZ, ALUMINIUM

		Klosz transparentny Transparent diffuser Transparent Abdeckung	Klosz mleczny Opal diffuser Opal Abdeckung	Zaślepka End cap Endkappe	Zaślepka End cap Endkappe
2 m	PROF-INLINE-Z-TR-AL-2M-1W	PROF-INLINE-Z-OP-AL-2M-1W	OP2-ZASL-IN-Z-SZ-01	OP2-ZASL-IN-Z-O-SZ-01	
3 m	PROF-INLINE-Z-TR-AL-3M-1W	PROF-INLINE-Z-OP-AL-3M-1W	OP2-ZASL-IN-Z-SZ-01	OP2-ZASL-IN-Z-O-SZ-01	
2 m	PROF-INLINE-Z-TR-BI-2M-1W	PROF-INLINE-Z-OP-BI-2M-1W	OP2-ZASL-IN-Z-BI-01	OP2-ZASL-IN-Z-BI-01	
2 m	PROF-INLINE-Z-TR-CZ-2M-1W	PROF-INLINE-Z-OP-CZ-2M-1W	OP2-ZASL-IN-Z-CZ-01	OP2-ZASL-IN-Z-CZ-01	

119. PROFIL ZENOLINE 2 M, 3 M BIAŁY, CZARNY, ALUMINIUM | WHITE, BLACK, ALUMINIUM | WEISS, SCHWARZ, ALUMINIUM

		Klosz mleczny Opal diffuser Opal Abdeckung	Zaślepka End cap Endkappe
Biały White Weiß	2m	PROFIL-ZENOLINE-OP-2M-B	OP2-ZASL-ZLINE-BI-01
	3m	PROFIL-ZENOLINE-OP-3M-B	
Czarny Black Schwarz	2m	PROFIL-ZENOLINE-OP-2M-C	OP2-ZASL-ZLINE-CZ-01
	3m	PROFIL-ZENOLINE-OP-3M-C	
Aluminium Aluminium Aluminium	2m	PROFIL-ZENOLINE-OP-2M-W	OP2-ZASL-ZLINE-SZ-01
	3m	PROFIL-ZENOLINE-OP-3M-W	

120. PROFIL TREND MLECZNY | OPAL | OPAL

		Mleczny Opal Opal	Zaślepka End cap Endkappe
Trend 10x10	2 m	PRO-TREND-10x10-2M-OP-01	OP2-Z-TREND-10x10-OP-01
Trend 15x15	2 m	PRO-TREND-15x15-2M-OP-01	OP2-Z-TREND-15x15-OP-01

Tworzywo sztuczne | Plastic | Kunststoff

! Profil oferowany z kloszem, zaślepki i uchwyty dostępne osobno | Profile is available with diffuser, end caps and brackets are offered separately | Profile werden mit Abdeckung angeboten, Endkappen und Montagehalterung sind einzeln erhältlich

! **WAŻNE! PROFILE OFEROWANE BEZ TAŚMY LED** | PROFILES OFFERED WITHOUT LED STRIPS | PROFILE WERDEN OHNE LED STREIFEN ANGEBOten

! **TOLERANCJA DŁUGOŚCI PROFILI I KŁOSZY WYNOŚI +/- 2 MM** | THE TOLERANCE OF THE LENGTH OF PROFILES AND DIFFUSERS IS +/- 2 MM | DIE TOLERANZ DER LÄNGE VON PROFILEN UND ABDECKUNGEN BETRÄGT +/- 2 MM

PROFILE ARCHITEKTONICZNE DO PŁYT G-K
| ARCHITECTONIC PROFILES FOR PLASTERBOARD PANELS
| TROCKENBAUPROFILE FÜR GIPSKARTON-PLATTEN

121. DEOLINE TYP P 2 M, 3 M ALUMINIUM | ALUMINIUM | ALUMINIUM

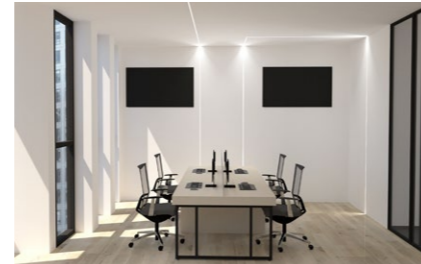
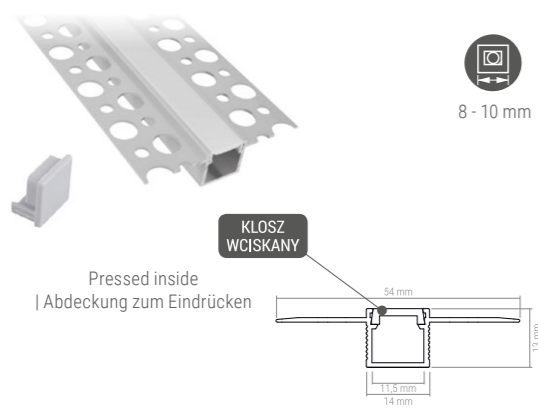

	Klosz mleczny Opal diffuser Opal Abdeckung Опал крышка	Zaślepka End cap Endkappe
2 m	PROFIL-DEOLINE-P-OP-2M-W	OP2-ZASL-13x14-SZ-02
3 m	PROFIL-DEOLINE-P-OP-3M-W	OP2-ZASL-13x14-SZ-02

122. DEOLINE TYP W 2 M, 3 M ALUMINIUM | ALUMINIUM | ALUMINIUM

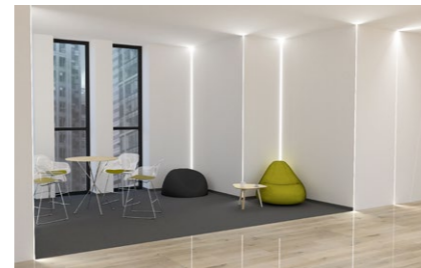
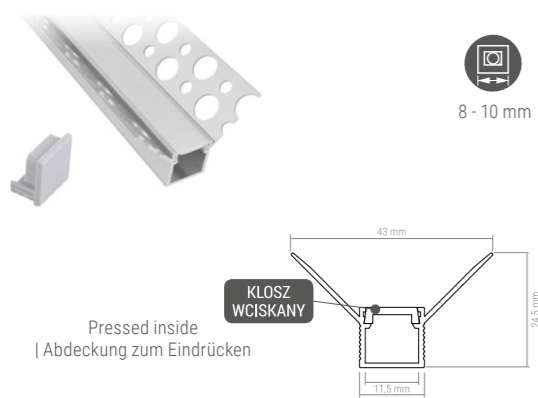

	Klosz mleczny Opal diffuser Opal Abdeckung Опал крышка	Zaślepka End cap Endkappe
2 m	PROFIL-DEOLINE-W-OP-2M-W	OP2-ZASL-13x14-SZ-02
3 m	PROFIL-DEOLINE-W-OP-3M-W	OP2-ZASL-13x14-SZ-02

123. DEOLINE TYP Z 2 M, 3 M ALUMINIUM | ALUMINIUM | ALUMINIUM

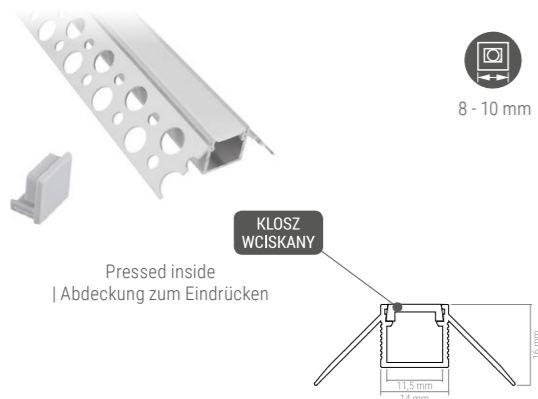

	Klosz mleczny Opal diffuser Opal Abdeckung Опал крышка	Zaślepka End cap Endkappe
2 m	PROFIL-DEOLINE-Z-OP-2M-W	OP2-ZASL-13x14-SZ-02
3 m	PROFIL-DEOLINE-Z-OP-3M-W	OP2-ZASL-13x14-SZ-02

! Profil oferowany z kloszem, zaślepką i uchwyty dostępne osobno | Profile is available with diffuser, end caps and brackets are offered separately | Profile werden mit Abdeckung angeboten, Endkappen und Montagehalterung sind einzeln erhältlich

! WAŻNE! PROFILE OFEROWANE BEZ TAŚMY LED | PROFILES OFFERED WITHOUT LED STRIPS | PROFILE WERDEN OHNE LED STREIFEN ANGEBOTEN

! TOLERANCJA DŁUGOŚCI PROFILI I KŁOSZY WYNOŚI +/- 2 MM | THE TOLERANCE OF THE LENGTH OF PROFILES AND DIFFUSERS IS +/- 2 MM | DIE TOLERANZ DER LÄNGE VON PROFILEN UND ABDECKUNGEN BETRÄGT +/- 2 MM

124. DEOLINE XL TYP P 2 M, 3 M ALUMINIUM | ALUMINIUM | ALUMINIUM



	Klosz mleczny Opal diffuser Opal Abdeckung Опал крышка	Zaślepka End cap Endkappe
1 m	PROF-DEOLINEXL-AL-OP-2M	OP2-ZASL-DEOLINEXL-SZ-01
2 m	PROF-DEOLINEXL-AL-OP-3M	OP2-ZASL-DEOLINEXL-SZ-01

125. DEOLINE TYP C 2 M, 3 M ALUMINIUM | ALUMINIUM | ALUMINIUM

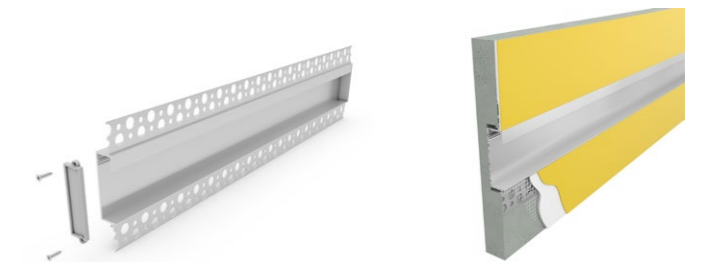
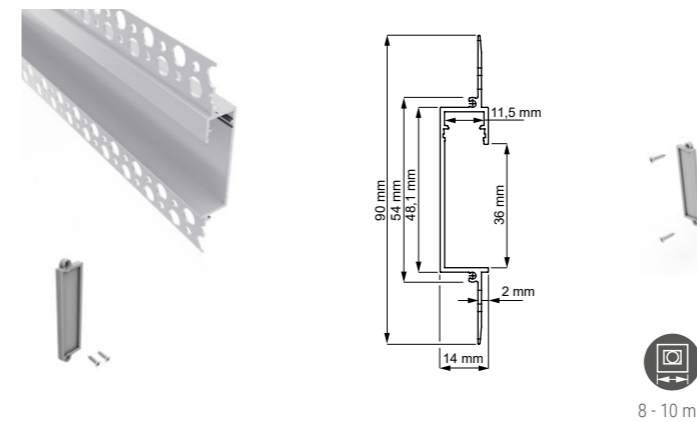

	Profil bez klosza Profile without diffuser Profil ohne Abdeckung	Zaślepka End cap Endkappe
2 m	PROFIL-DEOLINE-C-2M-W	OP2-ZASL-DEOLINE-C-SZ-01W
3 m	PROFIL-DEOLINE-C-3M-W	OP2-ZASL-DEOLINE-C-SZ-01W

Klosze oferowane są jako akcesoria dodatkowe | Diffusers are offered as additional accessories | Abdeckungen sind als Zubehör separat erhältlich.

126. DEOLINE TYP J 2 M, 3 M ALUMINIUM | ALUMINIUM | ALUMINIUM

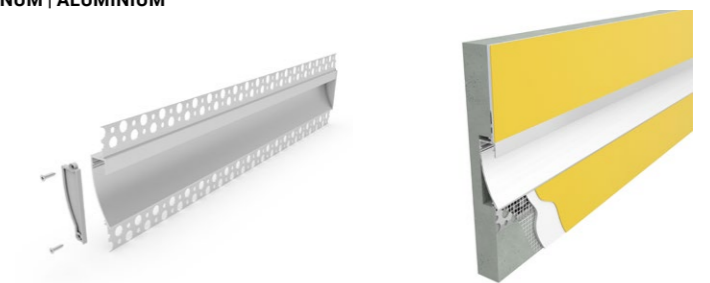
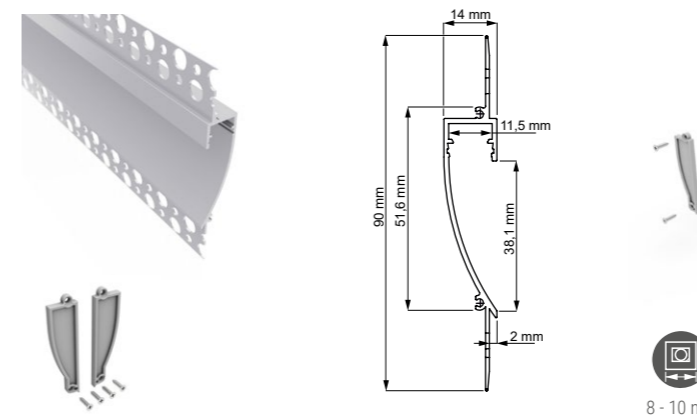

	Profil bez klosza Profile without diffuser Profil ohne Abdeckung	Zaślepka lewa + prawa Left and right + caps Endkappe links + rechts
2 m	PROFIL-DEOLINE-J-2M-W	OP2-ZASL-DEOLINE-J-SZ-01W
3 m	PROFIL-DEOLINE-J-3M-W	OP2-ZASL-DEOLINE-J-SZ-01W

Klosze oferowane są jako akcesoria dodatkowe | Diffusers are offered as additional accessories | Abdeckungen sind als Zubehör separat erhältlich.

SERIA ASTRO - PROFILE ARCHITEKTONICZNE
| ASTRO SERIES - ARCHITECTONIC PROFILES
| ASTRO-SERIE - TROCKENBAUPROFILE

127. JAPET 2 M, 3 M ALUMINIUM | ALUMINUM | ALUMINIUM

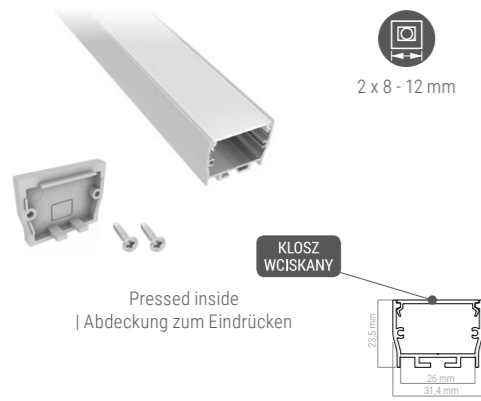

LACZ-AST-90-PZ-SN-01W
 Łącznik płaski 90 stopni + 4 wkręty do Japet, Japet XL, Fobos, Fobos XL.
 | Flat connector 90 degrees + 4 screws for Japet, Japet XL, Fobos, Fobos XL.
 | Flachverbinder 90 Grad + 4 Schrauben für Japet, Japet XL, Fobos, Fobos XL.

LACZ-AST-PZ-SN-01W
 Łącznik płaski prosty + 4 wkręty do Japet, Japet XL, Fobos, Fobos XL.
 | Flat connector + 4 screws for Japet, Japet XL, Fobos, Fobos XL.
 | Gerader Flachverbinder + 4 Schrauben für Japet, Japet XL, Fobos, Fobos XL.

	Klosz mleczny Opal diffuser Opal Abdeckung Опал крышка	Zaślepka End cap Endkappe
2 m	PROF-JAPET-AL-OP-2M	OP2-ZASL-JAPET-SZ-01W
3 m	PROF-JAPET-AL-OP-3M	OP2-ZASL-JAPET-SZ-01W

128. JAPET XL 2 M ALUMINIUM, 3 M ALUMINIUM, CZARNY | ALUMINIUM, BLACK | ALUMINIUM, SCHWARZ

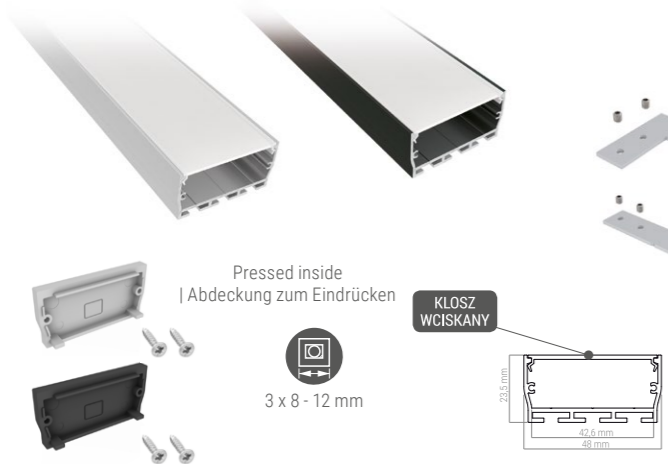

LACZ-AST-90-PZ-SN-01W
 Łącznik płaski 90 stopni + 4 wkręty do Japet, Japet XL, Fobos, Fobos XL.
 | Flat connector 90 degrees + 4 screws for Japet, Japet XL, Fobos, Fobos XL.
 | Flachverbinder 90 Grad + 4 Schrauben für Japet, Japet XL, Fobos, Fobos XL.

LACZ-AST-PZ-SN-01W
 Łącznik płaski prosty + 4 wkręty do Japet, Japet XL, Fobos, Fobos XL.
 | Flat connector + 4 screws for Japet, Japet XL, Fobos, Fobos XL.
 | Gerader Flachverbinder + 4 Schrauben für Japet, Japet XL, Fobos, Fobos XL.

	Klosz transparentny Transparent diffuser Transpa- rent Abdeckung	Zaślepka End cap Endkappe
2m	PROF-JAPETXL-AL-OP-2M	OP2-ZASL-JAPETXL-SZ-01W
3m	PROF-JAPETXL-AL-OP-3M	OP2-ZASL-JAPETXL-SZ-01W
3m	PROF-JAPETXL-CZ-OP-3M	OP2-ZASL-JAPETXL-CZ-01W

129. FOBOS 2 M, 3 M ALUMINIUM | ALUMINIUM | ALUMINIUM

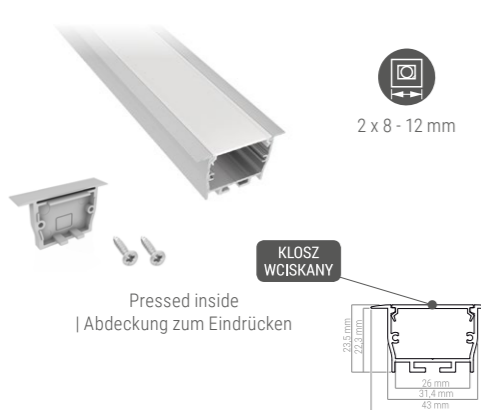

SPR-AST-30-PD-01W
 Sprężyna mocująca do FOBOS i FOBOS XL,
 uginana pod kątem 30 stopni.
 | Fixing spring for FOBOS and FOBOS XL, with 30 degree
 bending range.
 | Montagefeder für FOBOS und FOBOS XL, Biege Winkel
 30 Grad.

LACZ-AST-90-PZ-SN-01W
 Łącznik płaski 90 stopni + 4 wkręty do Japet, Japet XL, Fobos, Fobos XL.
 | Flat connector 90 degrees + 4 screws for Japet, Japet XL, Fobos, Fobos XL.
 | Flachverbinder 90 Grad + 4 Schrauben für Japet, Japet XL, Fobos, Fobos XL.

LACZ-AST-PZ-SN-01W
 Łącznik płaski prosty + 4 wkręty do Japet, Japet XL, Fobos, Fobos XL.
 | Flat connector + 4 screws for Japet, Japet XL, Fobos, Fobos XL.
 | Gerader Flachverbinder + 4 Schrauben für Japet, Japet XL, Fobos, Fobos XL.

	Klosz mleczny Opal diffuser Opal Abdeckung Опал крышка	Zaślepka End cap Endkappe
2 m	PROF-FOBOS-AL-OP-2M	OP2-ZASL-FOBOS-SZ-01W
3 m	PROF-FOBOS-AL-OP-3M	OP2-ZASL-FOBOS-SZ-01W

130. FOBOS XL 2 M, 3 M ALUMINIUM | ALUMINIUM | ALUMINIUM



SPR-AST-30-PD-01W
 Sprężyna mocująca do FOBOS i FOBOS XL,
 uginana pod kątem 30 stopni.
 | Fixing spring for FOBOS and FOBOS XL, with 30 degree
 bending range.
 | Montagefeder für FOBOS und FOBOS XL, Biege Winkel
 30 Grad.

LACZ-AST-90-PZ-SN-01W
 Łącznik płaski 90 stopni + 4 wkręty do Japet, Japet XL, Fobos, Fobos XL.
 | Flat connector 90 degrees + 4 screws for Japet, Japet XL, Fobos, Fobos XL.
 | Flachverbinder 90 Grad + 4 Schrauben für Japet, Japet XL, Fobos, Fobos XL.

LACZ-AST-PZ-SN-01W
 Łącznik płaski prosty + 4 wkręty do Japet, Japet XL, Fobos, Fobos XL.
 | Flat connector + 4 screws for Japet, Japet XL, Fobos, Fobos XL.
 | Gerader Flachverbinder + 4 Schrauben für Japet, Japet XL, Fobos, Fobos XL.

	Klosz mleczny Opal diffuser Opal Abdeckung Опал крышка	Zaślepka End cap Endkappe
2 m	PROF-FOBOSXL-AL-OP-2M	OP2-ZASL-FOBOSXL-SZ-01W
3 m	PROF-FOBOSXL-AL-OP-3M	OP2-ZASL-FOBOSXL-SZ-01W

131. NARVI 3 M ALUMINIUM, BIAŁY, CZARNY | ALUMINIUM, WHITE, BLACK | ALUMINIUM, WEISS, SCHWARZ



		Klosz mleczny Opal diffuser Opal Abdeckung	Zaślepka End cap Endkappe
Aluminium Aluminium Aluminium	3 m	PROF-NARVI-AL-OP-3M	OP2-ZASL-NARVI-SZ-01
Biały White Weiß	3 m	PROF-NARVI-BI-OP-3M	OP2-ZASL-NARVI-BI-01
Czarny Black Schwarz	3 m	PROF-NARVI-CZ-OP-3M	OP2-ZASL-NARVI-CZ-01





OPRAWY SUFITOWE

CEILING LUMINAIRES
DECKENLEUCHTEN

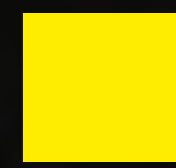

132. COSTA

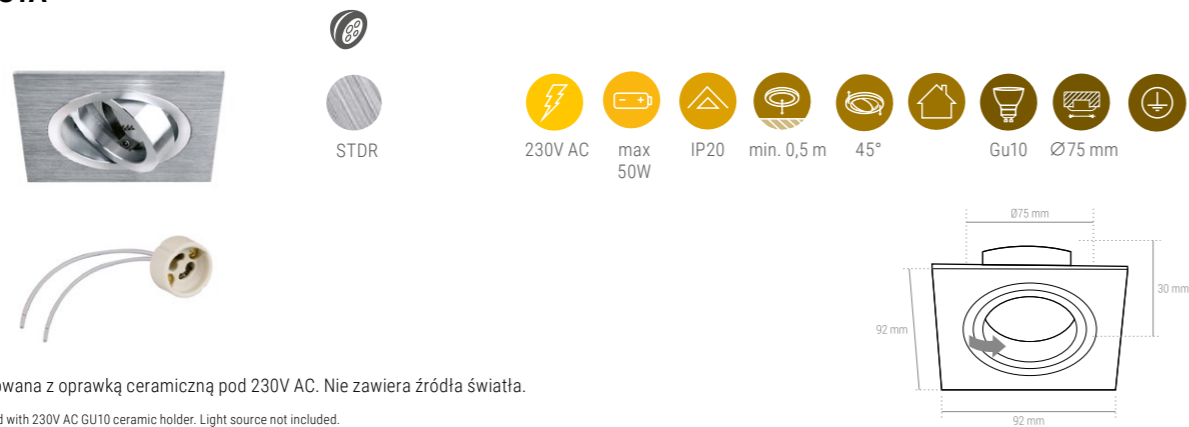

STDR

- 230V AC
- max 50W
- IP20
- min. 0,5 m
- 45°
- Gu10
- Ø75 mm

Oprawa oferowana z oprawką ceramiczną pod 230V AC. Nie zawiera źródła światła.

| Luminaire offered with 230V AC GU10 ceramic holder. Light source not included.
| Die Leuchte wird mit einer Keramikfassung für 230V AC angeboten. Lichtquelle nicht enthalten.

Indeks | Index | Index: COSTA-SN-01

133. BRAVA



BLACK

- 230V AC
- max 50W
- IP20
- min. 0,5 m
- 45°
- Gu10
- Ø80 mm

Oprawa oferowana z oprawką ceramiczną pod 230V AC. Nie zawiera źródła światła.

| Luminaire offered with 230V AC GU10 ceramic holder. Light source not included.
| Die Leuchte wird mit einer Keramikfassung für 230V AC angeboten. Lichtquelle nicht enthalten.

Indeks | Index | Index: BRAVA-CZ-01



134. LAMPA LED BROOKLYN | LED LAMP BROOKLYN | BROOKLYN LED HÄNGELEUCHTE-PENDELLEUCHTE

Indeks | Index | Index: BRK24-1000-40-CZ-OP-01

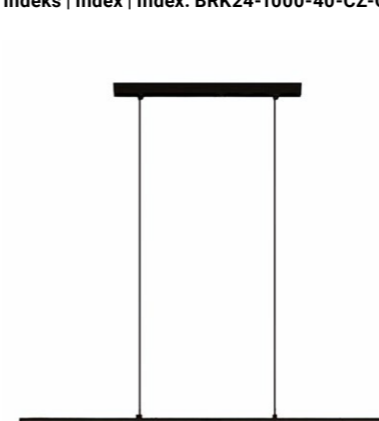

BLACK

Parametry źródła światła | Light source parameters | Parameter der Lichtquelle:

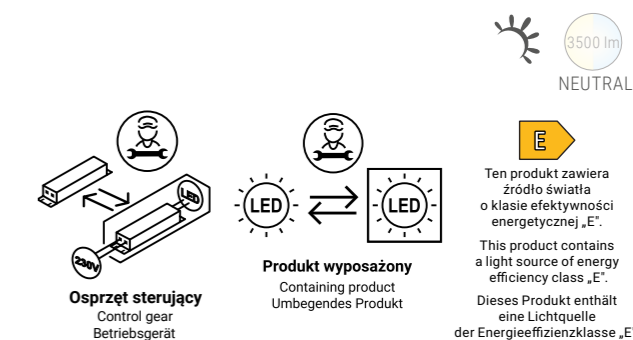

- 230V AC
- max 60W
- IP20

Produkt zawiera komplet uchwyty montażowych.

| The product includes a set of mounting brackets.
| Das Produkt enthält eine Set Montagehalterungen.

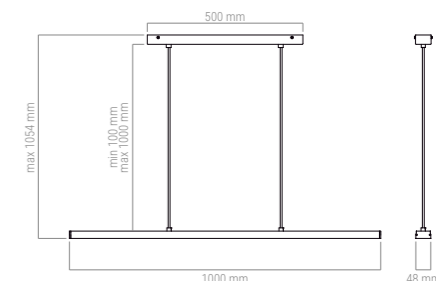

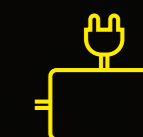

ZASILACZE LED

LED DRIVERS
LED NETZTEILE

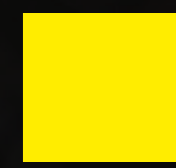

135. LED PREMIUM 24V 150W

PREMIUM



24V DC

☞ (W)	T max (°C)	L (mm)	H (mm)	W (mm)
150	80	180	31	65

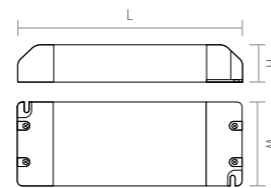

Indeks | Index | Index: TRA-24-S-150W-01

136. LED PREMIUM 24V 75W SLIM LONG

PREMIUM



24V DC



☞ (W)	T max (°C)	L (mm)	H (mm)	W (mm)
75	90	305	17	30

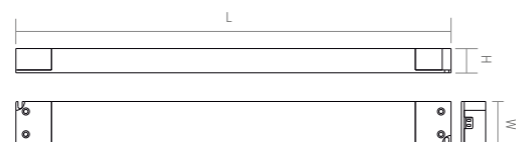

Indeks | Index | Index: TRA-24-SL-75W-T-02

137. LED PREMIUM 12V 75W SLIM LONG

PREMIUM



☞ (W)	T max (°C)	L (mm)	H (mm)	W (mm)
75	90	305	17	30

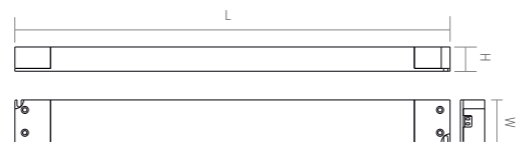

Indeks | Index | Index: TRA-SL-75W-T-02

138. LED PREMIUM 12V 6W, 8W, 15W, 30W, 50W, 75W, 100W, 132W, 180W, 216W, 260W

PREMIUM



☞ (W)	T max (°C)	L (mm)	H (mm)	W (mm)
6	80	99	11	46
8	75	95	20	46
15	80	102	16	35
30	85	156	17	50
50	85	160	18	58
75	80	201	31	63
100	80	180	31	65
132	80	180	31	65
180	80	195	31	67
216	90	195	31	67
260	85	215	36	77

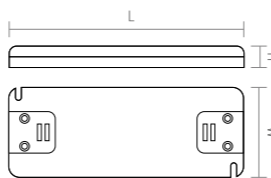

Indeks | Index | Index: TRA-S-(☞ (W))-T-01
TRA-S-(☞ (W))-T-02

139. LED PREMIUM 12V IP44 15W, 30W, 60W, 100W



IP44

☞ (W)	T max (°C)	L (mm)	H (mm)	W (mm)
15	80	130	15	41
30	85	158	17	51
60	90	167	18	58
100	90	167	18	58

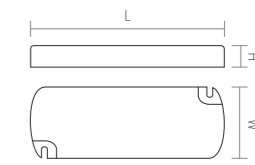

Indeks | Index | Index: TRA-S-IP44-(☞)-T-01

140. FLAT LED 6W, 15W, 30W, 40W, 60W

FLAT



☞ (W)	T max (°C)	L (mm)	H (mm)	W (mm)
6	75	100	15	43
15	85	151	13	44
30	80	170	17	55
40	80	170	17	55
60	75	265	18	59

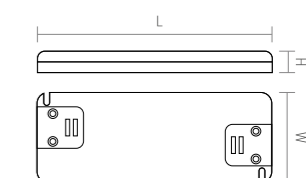
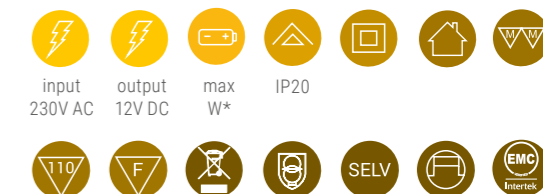

Indeks | Index | Index: TRA-F-(☞ (W))-T-01
TRA-F-(☞ (W))-T-02

141. ZASILACZE LED Z WBUDOWANYMI GNIAZDAMI MINI 15W | LED POWER SUPPLIES WITH BUILT-IN MINI SOCKETS

LED NETZTEILE MIT INTEGRIERTEN MINI-STECKDOSEN



15W

☞ (W)	T max (°C)	L (mm)	H (mm)	W (mm)
15	75	130	16	42

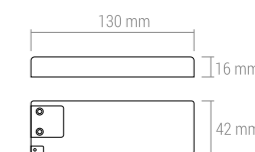

Indeks | Index | Index: TRA-LD-15W-T-01

142. ZASILACZE LED Z WBUDOWANYMI GNIAZDAMI MINI | LED POWER SUPPLIES WITH BUILT-IN MINI SOCKETS
| LED NETZTEILE MIT INTEGRIERTEN MINI-STECKDOSEN

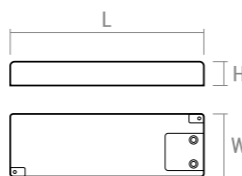
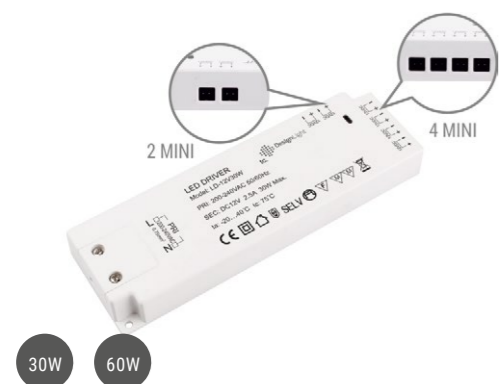

☞ (W)	T max (°C)	L (mm)	H (mm)	W (mm)
30	75	160	18	51
60	80	190	24	62

Indeks | Index | Index: TRA-LD-(☞)-T-01

143. LED STANDARD PLUS 24V 65W, 80W

STANDARD PLUS +

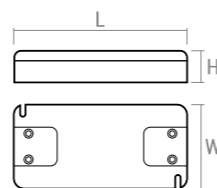
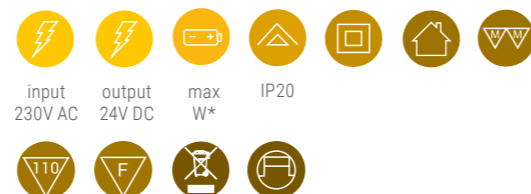

☞ (W)	T max (°C)	L (mm)	H (mm)	W (mm)
65	80	152	32	59
80	85	156	35	63

Indeks | Index | Index: TRA-24-SP-(☞)-02

144. LED STANDARD PLUS 7W, 12W, 16W, 24W, 33W, 54W, 65W, 80W, 150W, 200W

STANDARD PLUS +



☞ (W)	T max (°C)	L (mm)	H (mm)	W (mm)
7	75	86	22	35
12	75	106	23	43
16	75	106	23	43
24	75	140	25	47
33	80	140	25	47
54	80	152	32	59
65	80	152	32	59
80	80	156	35	63
150	85	205	35	71
200	85	205	35	71

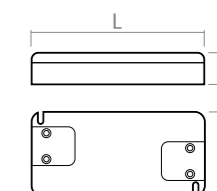

Indeks | Index | Index: TRA-SP-(☞ (W))-T-01

145. ZASILACZE MODUŁOWE | MODULAR POWER SUPPLIES | MODULARE NETZTEILE

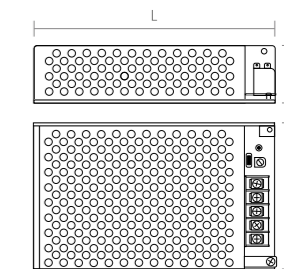
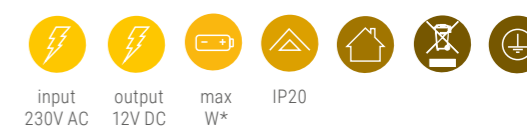

☞ (W)	T max (°C)	L (mm)	H (mm)	W (mm)
75	80	104	30	97
100	80	134	30	97
150	80	164	30	97
200	80	214	30	112
350	80	214	30	112

Indeks | Index | Index: TRA-M-(☞ (W))-T-02

146. UKŁAD ZASILAJĄCY LED Z ROZDZIELACZEM 6-PKT 7W, 12W, 16W, 24W, 33W | LED POWER SUPPLY SYSTEM WITH 6-PTS DIVIDER 7W, 12W, 16W, 24W, 33W | LED NETZTEIL MIT 6ER VERTEILER 7W, 12W, 16W, 24W, 33W

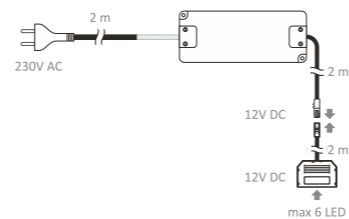
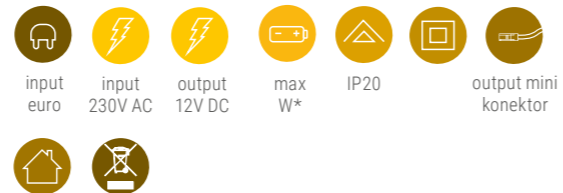
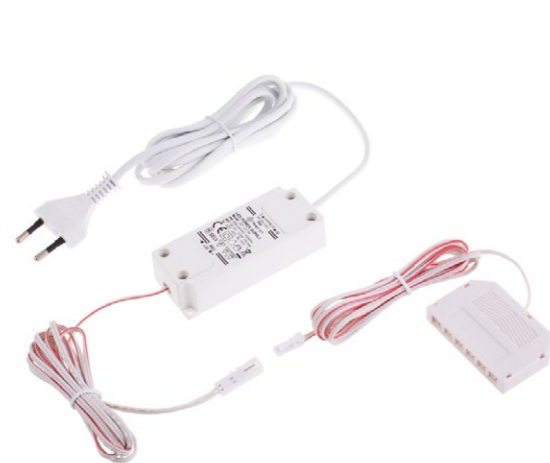

Indeks | Index | Index: U12-()-SP-2B0-4W6B

147. UKŁAD ZASILAJĄCY LED Z OKABLOWANIEM 7W, 12W, 16W, 24W, 33W | LED POWER SUPPLY SYSTEM WITH CABLES 7W, 12W, 16W, 24W, 33W | LED NETZTEIL MIT BÜCHSE 7W, 12W, 16W, 24W, 33W

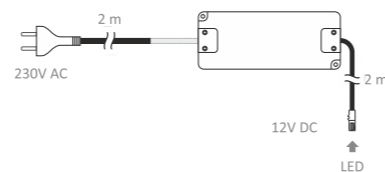

Indeks | Index | Index: U12-()-SP-2B0-201B

148. UKŁAD ZASILAJĄCY LED Z ROZDZIELACZEM 6-PKT I WYŁĄCZNIKIEM 7W, 12W, 16W, 24W, 33W | LED POWER SUPPLY SYSTEM WITH 6-PTS DIVIDER AND SWITCH 7W, 12W, 16W, 24W, 33W | LED NETZTEIL MIT 6ER VERTEILER UND SCHALTER 7W, 12W, 16W, 24W, 33W

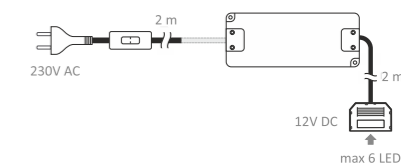
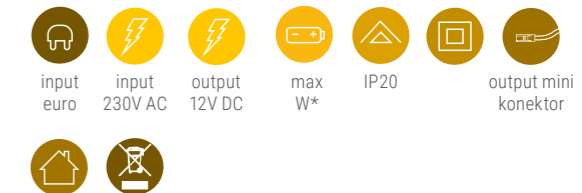

Indeks | Index | Index: U12-()-SP-2B1-206B

149. UKŁAD ZASILAJĄCY LED Z ROZDZIELACZEM 6-PKT 7W, 12W, 16W, 24W, 33W | LED POWER SUPPLY SYSTEM WITH 6-PTS DIVIDER 7W, 12W, 16W, 24W, 33W | LED NETZTEIL MIT 6ER VERTEILER 7W, 12W, 16W, 24W, 33W

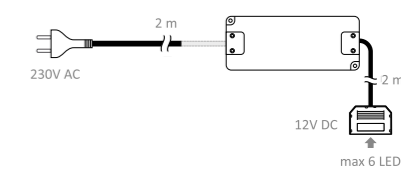
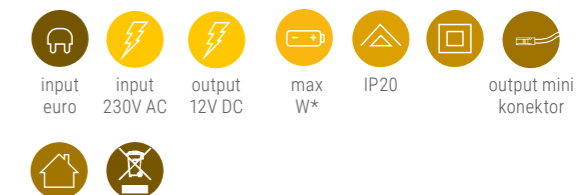

Indeks | Index | Index: U12-()-SP-2B0-206B

150. UKŁAD ZASILAJĄCY LED 38W Z WTYCZKĄ JACK LUB GNIAZDEM MINI | LED POWER SUPPLY SYSTEM 38W | LED NETZTEIL 38W MIT EURO-VERKABELUNG, JACK ODER MINI

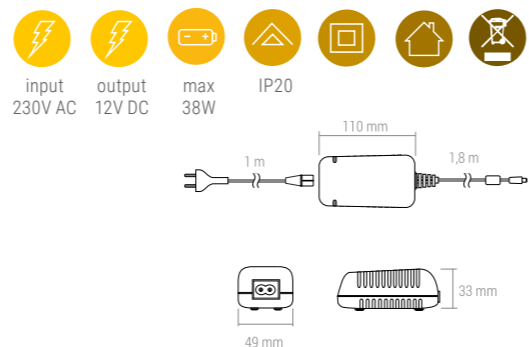

JACK Indeks | Index | Index: TRA-PLD-38
MINI Indeks | Index | Index: TRA-PLD-38W-01

151. UKŁAD ZASILAJĄCY LED 1,8W | LED POWER SUPPLY SYSTEM 1,8W | LED NETZTEIL 1,8W

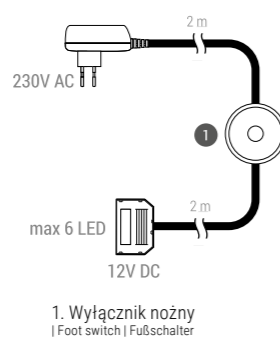

Indeks | Index | Index: ZSIM-12DC-1,8W-MNW

152. UKŁAD ZASILAJĄCY LED 6W | LED POWER SUPPLY SYSTEM 6W | LED NETZTEIL 6W

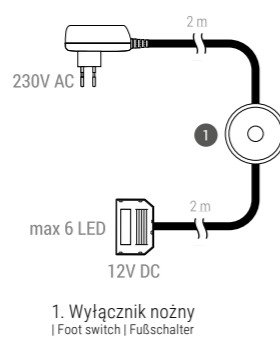

Indeks | Index | Index: ZSI-12DC-6W-MIN-22

153. UKŁAD ZASILAJĄCY LED 18W | LED POWER SUPPLY SYSTEM 18W | LED NETZTEIL 18W

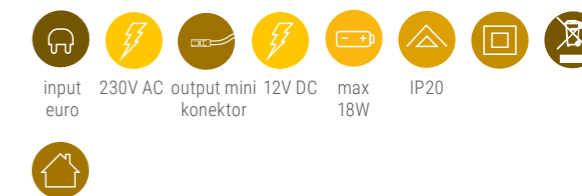
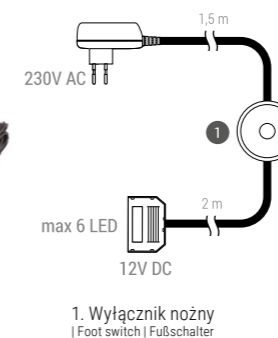

Indeks | Index | Index: ZAS-SI-12DC-18W-MNW

154. ZASILACZ LED 12W Z WTYCZKĄ JACK | LED DRIVER 12W WITH JACK PLUG OUTPUT | NETZTEIL 12W MIT JACKSTECKER

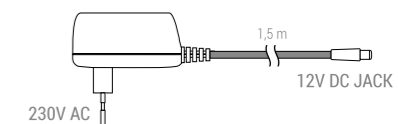
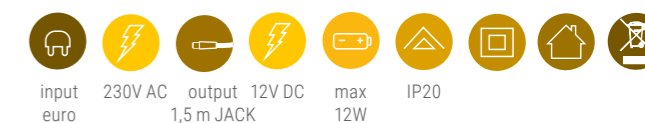

Indeks | Index | Index: ZAS-12DC-12W

155. OKABLOWANIE PRZEDŁUŻAJĄCE Z ROZDZIELACZEM 6 PKT | EXTENSION CABLE WITH 6-PTS DIVIDER | VERKABELUNG MIT VERLÄNGERUNG UND 6-FACHVERTEILER

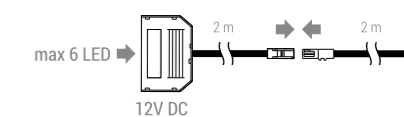
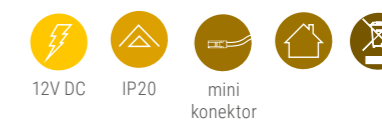

Indeks | Index | Index: OKS-MIN-WYL-01W

156. SYSTEM ZASILANIA SZYNOPRZEWODEM POWER TRACK DO OŚWIETLANIA REGAŁÓW SKLEPOWYCH | BUSBAR POWER SUPPLY SYSTEM POWER TRACK FOR ILLUMINATING SHOP SHELVES | STROMVERSORGUNGSSYSTEM DER SCHIENENBELEUCHTUNG POWER TRACK VON LADENREGALEN

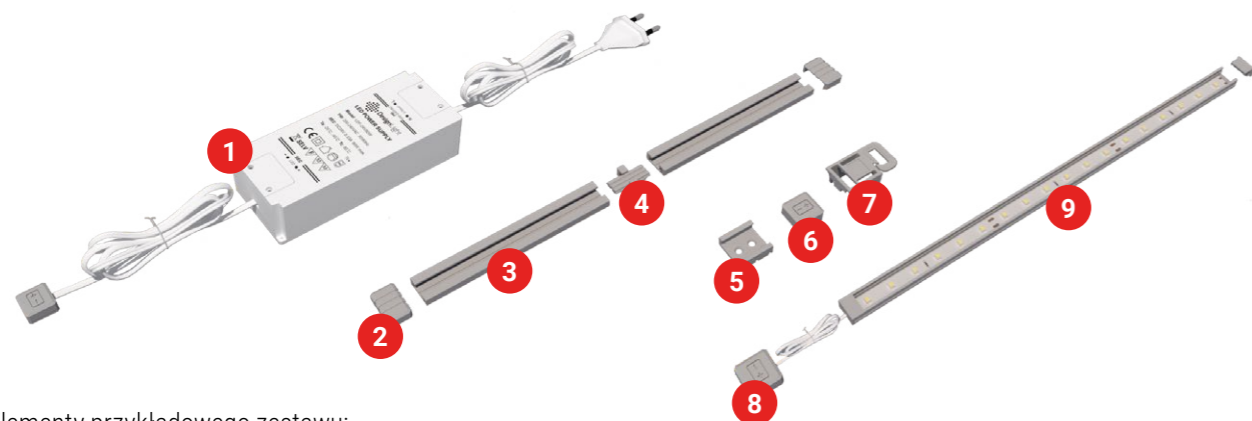

Elementy przykładowego zestawu:

| Elements of the example set:
| Elemente des Sample-Sets:



Zeskanuj kod smartfonem i zobacz film jak to działa.
Scan QR code with a smartphone and watch a video of how it works.
Scannen Sie den Code QR mit Ihrem Smartphone und sehen Sie sich das Video an, wie es funktioniert.

Zasilacz LED STANDARD PLUS 24V 80W

- 1 | LED driver STANDARD PLUS 24V 80W
| LED-Stromversorgung STANDARD PLUS 24V 80W

Power Track zaślepka końcowa do szyny - PT-ZASL-SZ-01

- 2 | Power Track End Cap for channel - PT-ZASL-SZ-01
| Endkappe für Stromschiene für Schiene - PT-ZASL-SZ-01

Power Track szyna dł. max 2 m z możliwością przedłużenia konektorem - PT-SZYNA-SZ-(długość)-01

- 3 | Power Track channel length max. 2 m with possibility of extension with connector - PT-SZYNA-SZ-(length)-01
| Power Track Schienenlänge max. 2 m mit Erweiterungsmöglichkeit mit Verbinder - PT-SZYNA-SZ-(Länge)-01

Power Track łącznik do szyny - PT-LACZ-SZ-01

- 4 | Power Track channel connector - PT-LACZ-SZ-01
| Power Track Schienenverbinder - PT-LACZ-SZ-01

Power Track uchwyty z wkrętami mocujący do szyny - PT-UCH-SZ-01

- 5 | Power Track channel mounting bracket with screws - PT-UCH-SZ-01
| Power Track Halterung mit Schrauben für die Schienenbefestigung - PT-UCH-SZ-01

Power Track wtyczka do szyny bez przewodu - PT-WTY-SZ-BP-01

- 6 | Power Track plug for channel without cable - PT-WTY-SZ-BP-01
| Power Track Stecker für die Schiene ohne Kabel - PT-WTY-SZ-BP-01

Power Track uchwyty zabezpieczające wtyczkę w szynie - PT-ZAB-WT-SZ-01

- 7 | Power Track holder securing the plug in the channel - PT-ZAB-WT-SZ-01
| Power Track Schutzhalterung des Steckers in der Schiene - PT-ZAB-WT-SZ-01

Power Track wtyczka z przewodem 2 x 0,50 mm² łącząca źródło światła z szyną - PT-WTY-L-SZ-(długość)-01

- 8 | Power Track plug with 2 x 0.50 mm² cable to connect the light source to the channel - PT-WTY-L-SZ-(length)-01
| Power Track Stecker mit Kabel 2 x 0,50 mm² Kabel zum Anschluss der Lichtquelle mit der Schiene - PT-WTY-L-SZ-(Länge)-01

Profil LED wraz z zaślepką oraz z dedykowaną taśmą przemysłową 24V DC.

- 9 | LED profile with end cap and dedicated industrial LED strip 24V DC.
| LED-Profil mit Endkappe und zugehörigem Industrie LED-Streifen 24V DC.

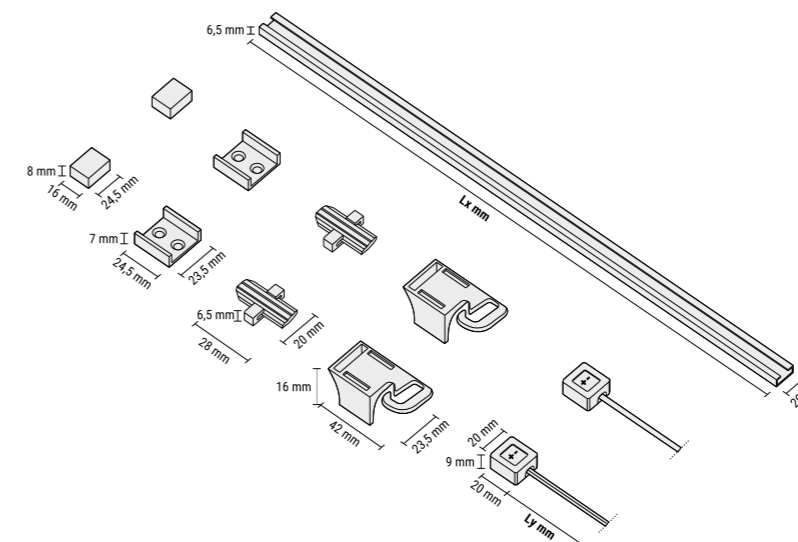

Lx mm - długość szyny (max 2 m)
Ly mm - długość przewodu

| Lx mm - channel length (max. 2 m)
| Ly mm - cable length

| Lx mm - Schienenlänge (max 2 m)
| Ly mm - Kabellänge

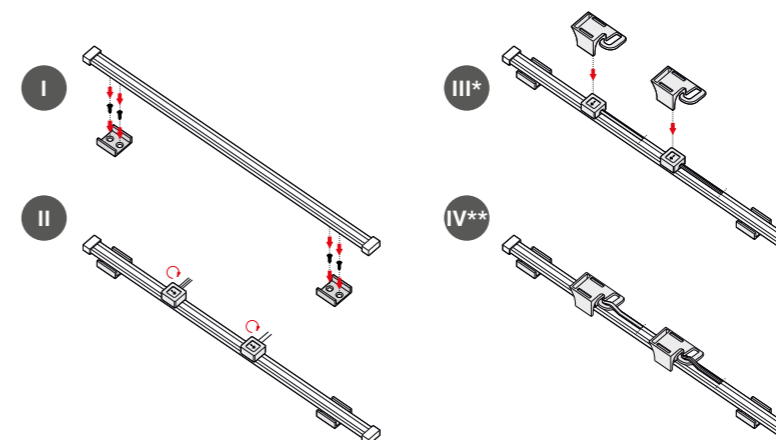

UWAGA:

* Podłączając oświetlenie do szyny, należy zwrócić uwagę, aby zachowana była jednakowa polaryzacja (+ do +, - do -) przy wtyczce zasilającej szynę (od zasilacza do szyny), jak i wtyczce zasilającej źródło światła (od szyny do źródła światła).

** Każdorazowo po zamontowaniu wtyczki do szyny, należy ją zabezpieczyć za pomocą uchwyty zabezpieczającego, tak aby styki wtyczki były dobrze dociśnięte do przewodów w szynie. W przeciwnym razie może dojść do przegrzewania się wtyczki i uszkodzenia produktu!

ATTENTION:

* When connecting the lighting to the power track channel, make sure that the polarity (+ to +, - to -) of the channel power plug (from the power supply to the channel) and the light source power plug (from the channel to the light source) is the same.

** Each time when the plug is mounted to the channel, it must be secured with a safety bracket, so that the plug contacts are well pressed against the wires in the rail. Otherwise, the plug may overheat and damage the product!!

ACHTUNG:

|* Beim Anschluss der Beleuchtung an die Schiene ist darauf zu achten, dass die Polarität (+ bis +, - bis -) des Netzsteckers (von der Stromversorgung zur Schiene) und des Netzsteckers der Lichtquelle (von der Schiene zur Lichtquelle) gleich ist.

|** Nach jeder Montage des Steckers an die Schiene, muss diese mit einer Schienenbefestigung gesichert werden, damit die Steckkontakte gut an die Verkabelung in der Schiene gedrückt sind. Andernfalls kann es zur Überhitzung der Steckverbinder kommen und das Produkt beschädigen!

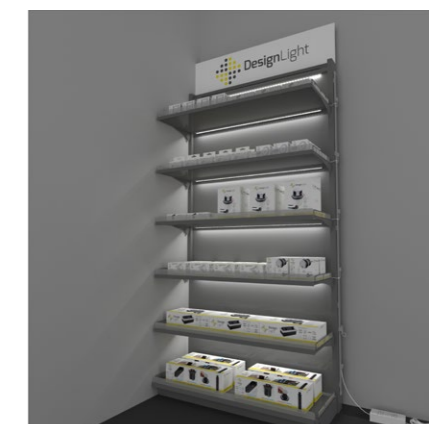

157. SYSTEM SMART

NOWOŚĆ
NEW! NEU!



Zeskanuj kod smartfonem i zobacz film jak to działa.
Scan QR code with a smartphone and watch a video of how it works.
Scannen Sie den Code QR mit Ihrem Smartphone und sehen Sie sich das Video an, wie es funktioniert.



Zasilacz SMART LED DRIVER do LED, 60W, 12V DC z 6 gniazdami mini - TRA-LDV-60W-01

A | SMART Power Supply, 60W, 12V DC, with 6 mini amp sockets - TRA-LDV-60W-01
| SMART LED Netzteil, 60W, 12V DC mit 6 Mini-Steckdosen - TRA-LDV-60W-01

Sterownik/konwerter do obsługi wyłączników przewodowych - STER-LDV-SW-01

B | Controller/converter for wired switches - STER-LDV-SW-01
| Controller/Konverter für verdrahtete Schalter - STER-LDV-SW-01

Sterownik/odbiornik RF do obsługi wyłączników bezprzewodowych OLI, DELI 2 i TEO - STER-LDV-RF-01

C | Controller/converter RF for wireless switches OLI, DELI 2, TEO - STER-LDV-RF-01
| Controller/RF-Empfänger zum Steuern der drahtlosen Schalter OLI, DELI 2 und TEO - STER-LDV-RF-01

Przewód łączący sygnał SCC, 2 m AV624, obustronnie wtyczka CH2.5-3P - PRZ-LDV-SCC-2M-B-01

D | Signal connection cable, 2-meter long AV624, CH2.5-3P plug at both ends - PRZ-LDV-SCC-2M-B-01
| SCC-Signalanschlusskabel, 2 m AV624, doppelseitiger Stecker CH2.5-3P - PRZ-LDV-SCC-2M-B-01

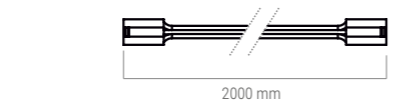
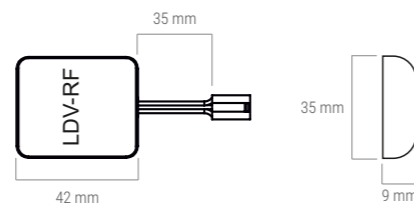
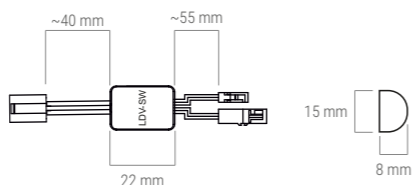
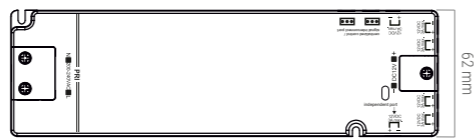
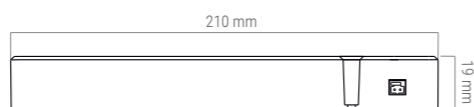

Podłącz szybko i sprawnie oświetlenie LED o mocy do 1200W.

Dzięki Systemowi SMART:

- łatwo skonfigurujesz system oświetlenia LED;
- bez względu na moc przyłączonego źródła światła, możesz użyć dowolnego wyłącznika 12V DC w opcji przewodowej lub radiowej;
- masz możliwość rozbudowy systemu o kolejne zasilacze SMART LED 60W aż do max. 20 szt. (1200W).

Quick and easy installation of LED lighting of up to 1200W.

Thanks to the SMART system:

- it's easy to configure your LED lighting system,
- you can use any 12V DC switch regardless the power consumption of the installed light sources,
- you get an opportunity to extend your system by adding other SMART LED 60W power supplies, even up to 20 pieces (1200 W).

Schließen Sie LED-Beleuchtung bis zu 1200W schnell und effizient an.

Mit dem SMART-System:

- LED-Beleuchtungssystem einfach konfigurieren;
- unabhängig von der Leistung der angeschlossenen Lichtquelle, können Sie jeden 12V Schalter, entweder drahtgebunden oder funkgesteuert verwenden;
- Sie haben die Möglichkeit, das System mit zusätzlichen SMART LED Netzteilen 60W mit bis zu max. 20 Stück (1200W) zu erweitern.

Przewód łączący zasilacze
| Cable for connecting power supplies
| Verbindungskabel für Netzteile

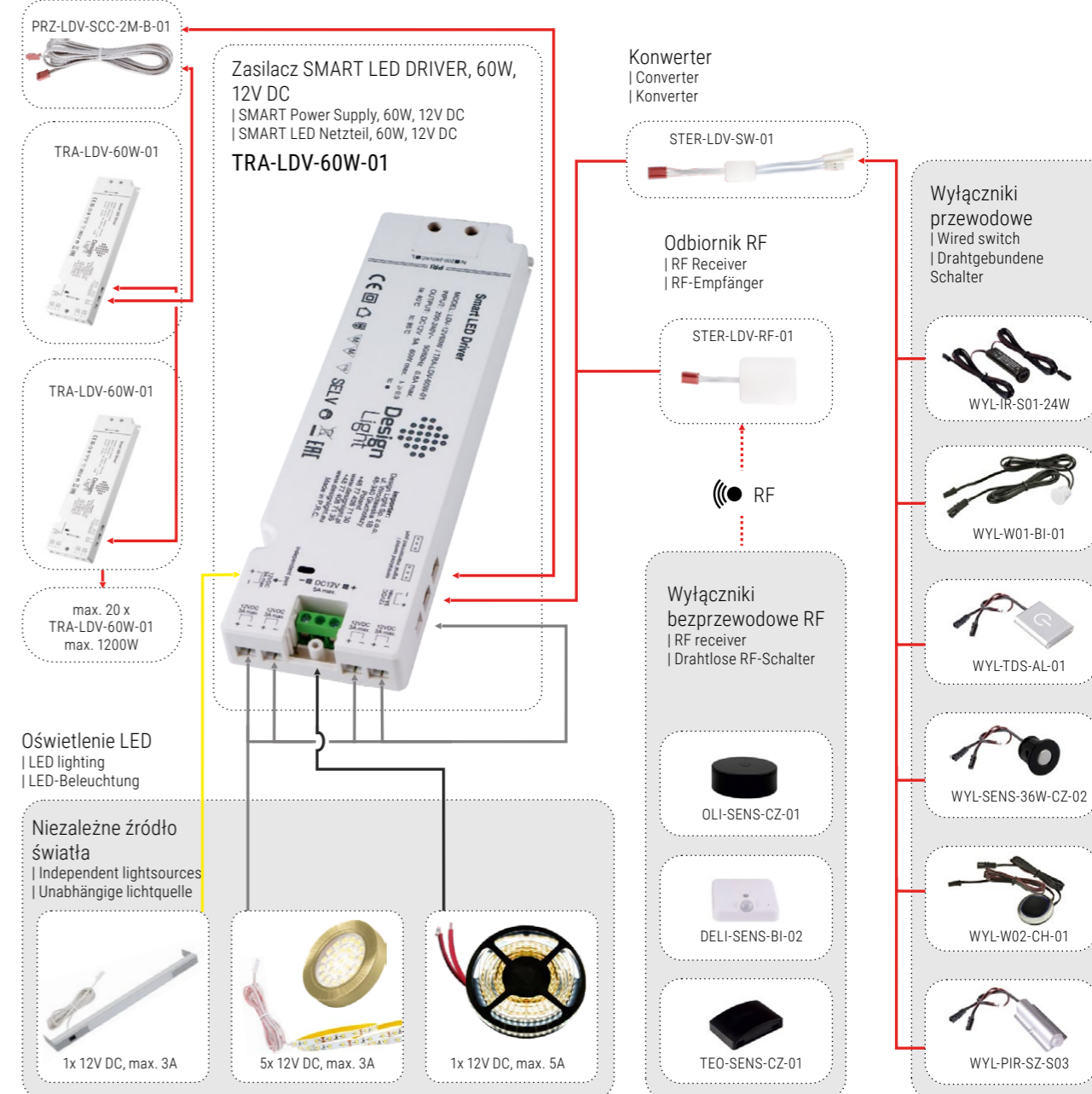



STEROWNIKI LED

LED CONTROLLERS
LED CONTROLLER



158. STEROWNIK RF MULTI 5W1 | LED CONTROLLER RF MULTI 5IN1 | CONTROLLER LED MULTI 5IN1



input/output 12V DC/24V DC 180W/360W

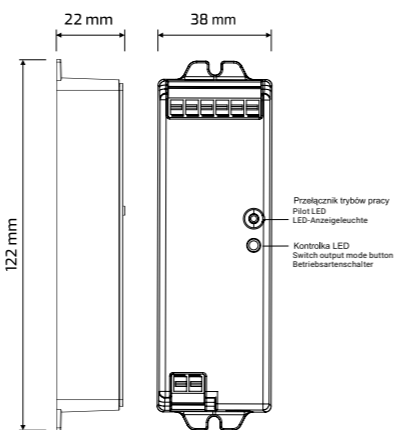

Sterownik jest obsługiwany za pomocą pilota RF do oświetlenia 4 strefowego LED (159).

The controller is operated with the RF remote control for 4-zone LED lighting (159). Der Controller wird mit der RF-Fernbedienung für 4-Zonen-LED-Beleuchtung betrieben (159).

Kolor kontrolki Pilot lamp color/ Farbe der Kontrolllampe	Tryb pracy Output Mode/ Betriebsart
Białe światło White light/ Weißes Licht	Mono kolor Single color mode/ Einzelfarbmodes
Żółte światło Yellow Light/ Gelbes Licht	CCT (Bicolor) Dual white mode/ Dualer Weißmodus
Czerwone światło Red Light / Rotes Licht	RGB
Zielone światło Green Light/ Grünes Licht	RGBW
Niebieskie światło Blue Lights/ Blaues Licht	RGB + CCT (Bicolor)



Zeskanuj kod smartfonem i zobacz film jak to działa. Scan QR code with a smartphone and watch a video of how it works. Scannen Sie den Code QR mit Ihrem Smartphone und sehen Sie sich das Video an, wie es funktioniert.

Indeks | Index | Index: MULTI-STER-BI-01

SCHEMAT PODŁĄCZENIA DO TAŚMY LED
Diagram of connection to the LED strip/ Montageschema für LED-Streifen

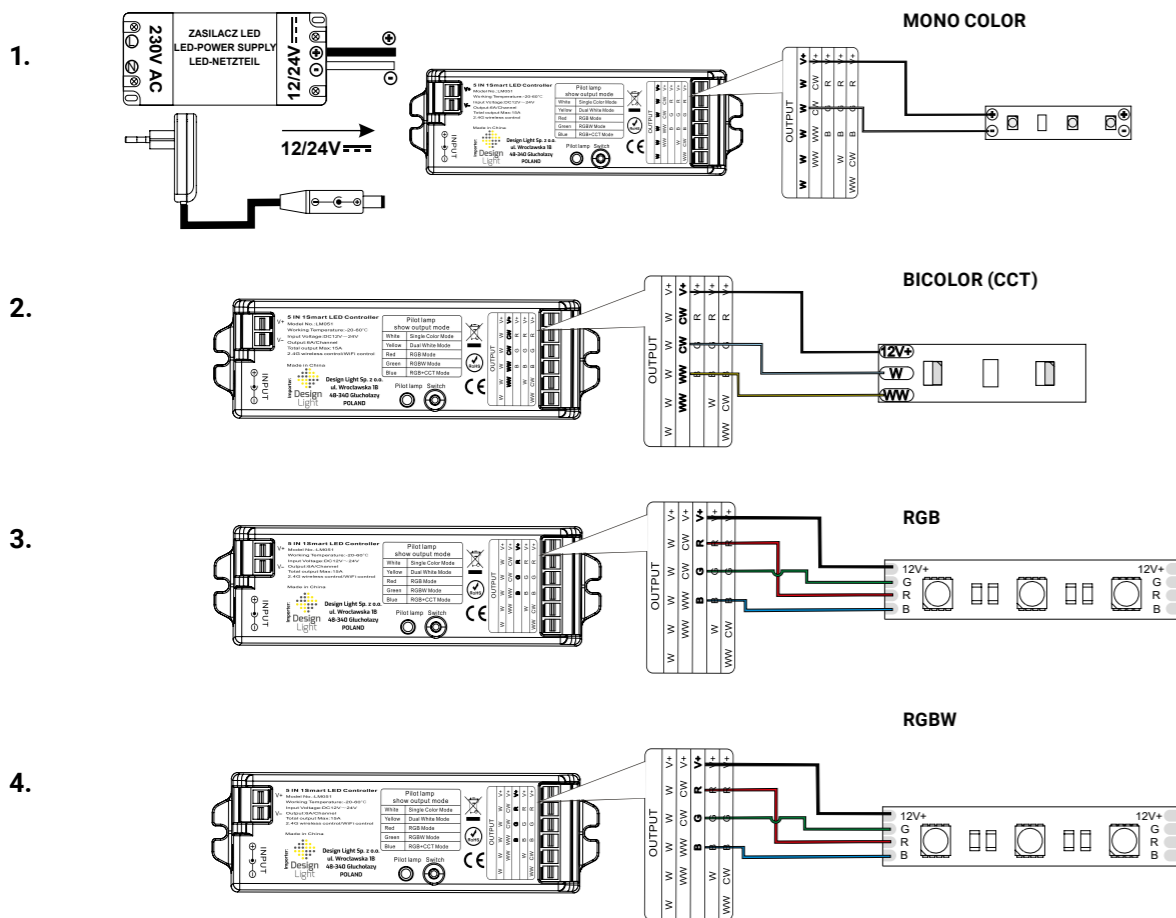

5 a. RGB + BICOLOR (RGB + CCT)

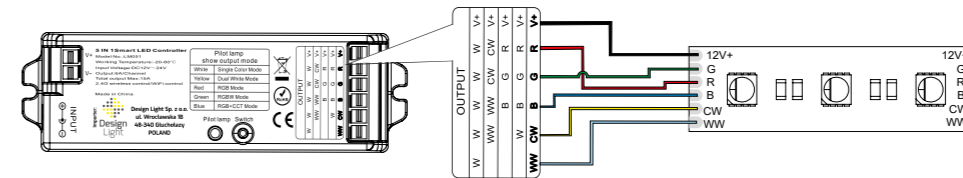

5 b. RGB + BICOLOR (RGB + CCT)



159. PILOT RF 4 STEFOWY MULTI 5W1 | RF REMOTE CONTROL 4 ZONES MULTI 5IN1 | RF FERNBEDIENUNG 4 ZONEN MULTI 5IN1

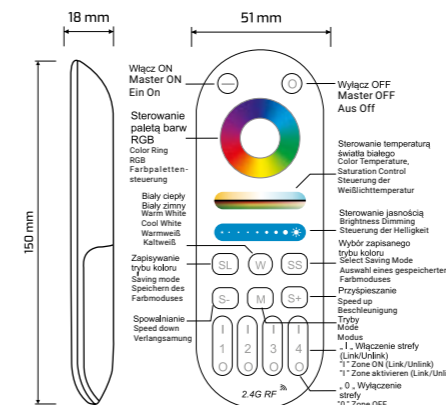

Zeskanuj kod smartfonem i zobacz film jak to działa. Scan QR code with a smartphone and watch a video of how it works. Scannen Sie den Code QR mit Ihrem Smartphone und sehen Sie sich das Video an, wie es funktioniert.

Brak baterii w zestawie
No Batteries included
Batterie nicht im Set enthalten

Indeks | Index | Index: MULTI-PILOT-BI-01

160. PILOT NAŚCIENNY 4-STREFOWY 5W1 MONO, BICOLOR (CCT), RGB, RGBW, RGB + BICOLOR (CCT) | 4-ZONE WALL REMOTE CONTROLLER 5IN1 | FERNBEDIENUNG FÜR DIE WANDMONTAGE 4-ZONEN 5IN1



Zeskanuj kod smartfonem i zobacz film jak to działa. Scan QR code with a smartphone and watch a video of how it works. Scannen Sie den Code QR mit Ihrem Smartphone und sehen Sie sich das Video an, wie es funktioniert.

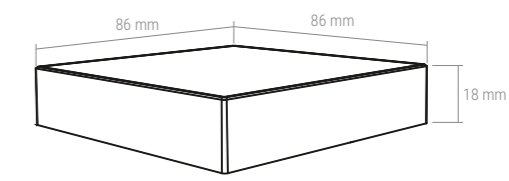

Brak baterii w zestawie
No Batteries included
Batterie nicht im Set enthalten

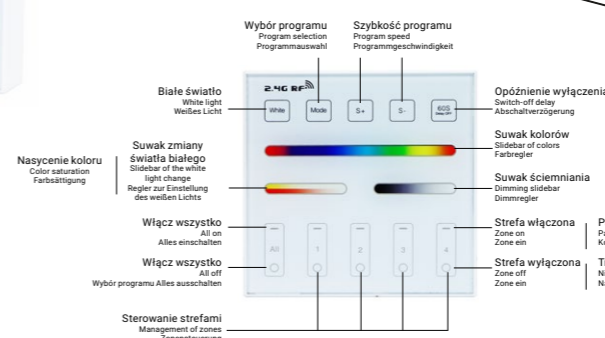

Indeks | Index | Index: MULTI-N-PILOT-BI-01

161. STEROWNIK RF MONO | LED CONTROLLER RF MONO | CONTROLLER LED MONO



Sterownik LED do konfigurowania zestawów oświetlenia strefowego. Jeden sterownik obsługuje tylko jedną strefę oraz wymaga podłączenia do zasilacza LED.

LED controller for configuring zone lighting sets. One controller supports only one zone and requires connection to an LED power supply. LED-Controller zur Konfiguration von Zonenbeleuchtungsanlagen. Ein Controller unterstützt nur eine Zone und benötigt den Anschluss an eine LED-Stromversorgung.

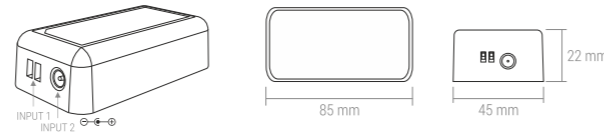

Indeks | Index | Index: STER-MONO-RF-10A-01

Sterownik jest obsługiwany za pomocą pilota RF do oświetlenia 4 strefowego LED (165.).

The controller is operated with the RF remote control for 4-zone LED lighting (165.). Der Controller wird mit der RF-Fernbedienung für 4-Zonen-LED-Beleuchtung betrieben (165.).

162. STEROWNIK RF RGB | LED CONTROLLER RF RGB | CONTROLLER LED RGB



Sterownik RGB jest obsługiwany za pomocą pilota RF do oświetlenia 4 strefowego LED (166.).

The controller is operated with the RF remote control for 4-zone LED lighting (166.). Der Controller wird mit der RF-Fernbedienung für 4-Zonen-LED-Beleuchtung betrieben (166.).

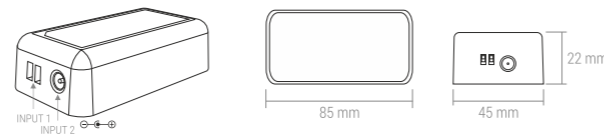
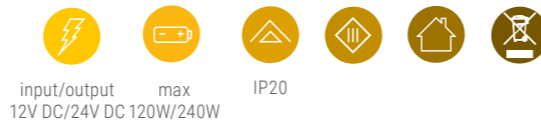

Indeks | Index | Index: STER-RGB-RF-10A-01

Sterownik LED RGB do konfigurowania zestawów oświetlenia strefowego. Jeden sterownik obsługuje tylko jedną strefę oraz wymaga podłączenia do zasilacza LED.

LED controller for configuring zone lighting sets. One controller supports only one zone and requires connection to an LED power supply. LED-Controller zur Konfiguration von Zonenbeleuchtungsanlagen. Ein Controller unterstützt nur eine Zone und benötigt den Anschluss an eine LED-Stromversorgung.



Zeskanuj kod smartfonem i zobacz film jak to działa.

Scan QR code with a smartphone and watch a video of how it works. Scannen Sie den Code QR mit Ihrem Smartphone und sehen Sie sich das Video an, wie es funktioniert.

163. STEROWNIK RF RGBW | LED CONTROLLER RF RGBW | CONTROLLER LED RGBW



Sterownik RGBW jest obsługiwany za pomocą pilota RF do oświetlenia 4 strefowego LED (166.).

The controller is operated with the RF remote control for 4-zone LED lighting (166.). Der Controller wird mit der RF-Fernbedienung für 4-Zonen-LED-Beleuchtung betrieben (166.).

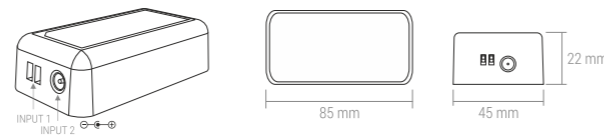
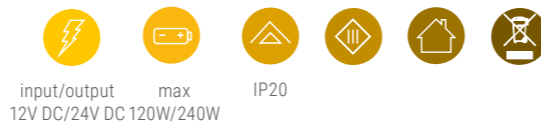

Indeks | Index | Index: STER-RGBW-RF-10A-01

Sterownik LED RGBW do konfigurowania zestawów oświetlenia strefowego. Jeden sterownik obsługuje tylko jedną strefę oraz wymaga podłączenia do zasilacza LED.

LED controller for configuring zone lighting sets. One controller supports only one zone and requires connection to an LED power supply. LED-Controller zur Konfiguration von Zonenbeleuchtungsanlagen. Ein Controller unterstützt nur eine Zone und benötigt den Anschluss an eine LED-Stromversorgung.



Zeskanuj kod smartfonem i zobacz film jak to działa.

Scan QR code with a smartphone and watch a video of how it works. Scannen Sie den Code QR mit Ihrem Smartphone und sehen Sie sich das Video an, wie es funktioniert.

164. STEROWNIK RF BICOLOR | LED CONTROLLER RF BICOLOR | CONTROLLER LED BICOLOR



Sterownik LED BICOLOR do konfigurowania zestawów oświetlenia strefowego. Umożliwia zmianę barwy światła pomiędzy ciepłą a zimną w taśmie LED z funkcją BICOLOR. Jeden sterownik obsługuje tylko jedną strefę oraz wymaga podłączenia do zasilacza LED.

LED controller for configuring zone lighting sets. Allows you to change the colour of light between warm and cool white in the LED strip with the BICOLOR function. One controller supports only one zone and requires connection to an LED power supply. LED-Controller zur Konfiguration von Zonenbeleuchtungsanlagen. Ermöglicht den Wechsel der Lichtfarbe zwischen warm und kalt im LED-Streifen mit der Funktion BICOLOR. Ein Controller unterstützt nur eine Zone und benötigt den Anschluss an eine LED-Stromversorgung.

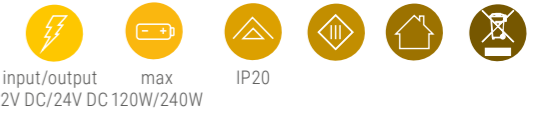

Zeskanuj kod smartfonem i zobacz film jak to działa.

Scan QR code with a smartphone and watch a video of how it works. Scannen Sie den Code QR mit Ihrem Smartphone und sehen Sie sich das Video an, wie es funktioniert.

Możliwość sterowania za pomocą aplikacji telefonicznej (Mi-Light Wi-Fi).

The ability to control using the smartphone application (Mi-Light Wi-Fi). | Möglichkeit der Steuerung über die Telefonanwendung (Mi-Light Wi-Fi).

Sterownik BICOLOR jest obsługiwany za pomocą pilota RF do oświetlenia 4 strefowego LED (165.).

The controller is operated with the RF remote control for 4-zone LED lighting (165.). Der Controller wird mit der RF-Fernbedienung für 4-Zonen-LED-Beleuchtung betrieben (165.).



Indeks | Index | Index: STER-BK-RF-10A-01

165. PILOT RF 4 STREFOWY MONO/BICOLOR | RF REMOTE CONTROL 4 ZONES MONO/BICOLOR | RF FERNBEDIENUNG 4 ZONEN MONO/BICOLOR



FUNKCJE PILOTA DLA STEROWNIKA MONO
FERNBEDIENUNGSFUNKTIONEN FÜR DEN MONO-CONTROLLER
REMOTE CONTROL FUNCTIONS FOR THE MONO CONTROLLER

FUNKCJE PILOTA DLA STEROWNIKA BICOLOR
FERNBEDIENUNGSFUNKTIONEN FÜR DEN BICOLOR-CONTROLLER
REMOTE CONTROL FUNCTIONS FOR THE BICOLOR CONTROLLER

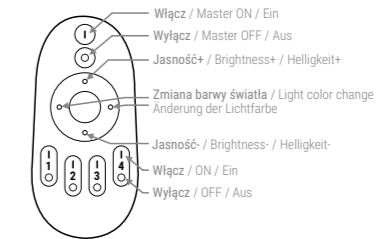
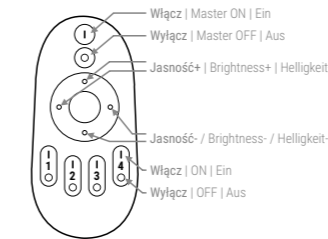

Brak baterii w zestawie

No Batteries included
Batterie nicht im Set enthalten

Uchwyt do pilota dostępny osobno

Holder for the remote control is available separately
Haltung separat erhältlich

Indeks pilot RF | Index RF remote control | Index RF Fernbedienung RF: STER-MON-RF-PILOT-01
Indeks uchwyt | Index Holder | Index Haltung: STER-UCHWYT-PILOT-01

166. PILOT RF 4 STREFOWY RGB | RGBW | RF REMOTE CONTROL 4 ZONES RGB AND RGBW | RF FERNBEDIENUNG 4 ZONEN RGB UND RGBW

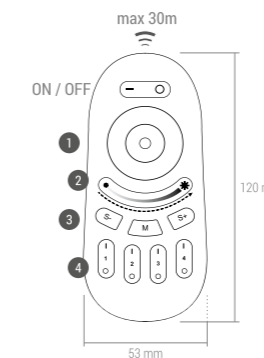

- Wybór barwy światła
Changing the color of light
Auswahl der Lichtfarbe
- Ustawianie jasności światła
Adjusting the brightness
Einstellung der Helligkeit
- Obsługa programów świecenia
Light programs
Bedienung der Leuchtprogramme
- Obsługa 4 stref oświetlenia
Operation 4 lighting zones
Bedienung von 4 Lichtzonen

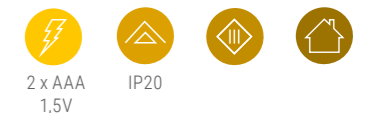

Brak baterii w zestawie

No Batteries included
Batterie nicht im Set enthalten

Uchwyt do pilota dostępny osobno

Holder for the remote control is available separately
Haltung separat erhältlich

Indeks pilot RF | Index RF remote control | Index RF Fernbedienung RF: STER-RGB-RF-PILOT-01
Indeks uchwyt | Index Holder | Index Haltung: STER-UCHWYT-PILOT-01

167. STEROWNIK LED RGB Z PILOTEM RF | LED RGB CONTROLLER WITH RF REMOTE | LED RGB CONTROLLER MIT RF FERNBEDIENUNG

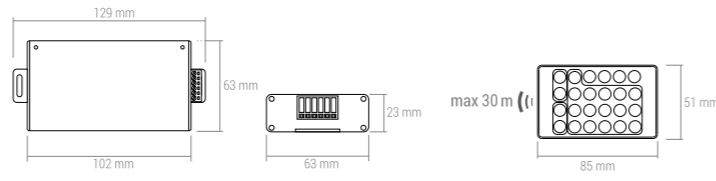

Sterownik obsługiwany pilotem RF o zasięgu 30 m. Dedykowany jest do oświetlenia LED RGB zasilanego stałym napięciem 12V DC nieprzekraczającym łącznego poboru prądu 12A.

LED RGB Controller is operated by RF remote with a range of 30 m. It is dedicated to LED RGB lighting supplied by 12V DC voltage, not exceeding the total current consumption of 12A. Controller RF mit Fernbedienung und einer Reichweite von 30 m. Dient der Beleuchtung RGB mit konstanter Spannung 12V DC die Gesamtstromaufnahme 12A nicht überschreitet.

Indeks | Index | Index: STER-RGB-RF-02

168. STEROWNIK LED RGB Z PILOTEM IR | LED RGB CONTROLLER WITH IR REMOTE | LED RGB CONTROLLER MIT IR FERNBEDIENUNG

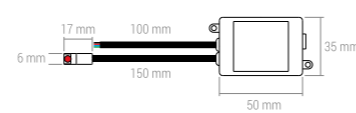

Sterownik obsługiwany pilotem IR o zasięgu 3 - 5 m. Dedykowany jest do oświetlenia LED RGB zasilanego stałym napięciem 12V DC nie przekraczającym łącznego poboru prądu 6A.

LED RGB Controller is operated by IR remote with a range of 3 - 5 m. It is dedicated to LED RGB lighting supplied by 12V DC voltage, not exceeding the total current consumption of 6A. Controller mit IR Fernbedienung und einer Reichweite von 3 - 5 m. Dient der Beleuchtung RGB mit konstanter Spannung 12V DC die Gesamtstromaufnahme 6A nicht überschreitet.

Indeks | Index | Index: STER-RGB-12DC-IR-6A

169. WYŁĄCZNIK KŁAWISZOWY ZE STEROWNIKIEM LED MONO RF | WALL MOUNTED SWITCH WITH MONO RF CONTROLLER | SCHALTER MIT RF-CONTROLLER FÜR DIE EINFARBIGE LED BELEUCHTUNG

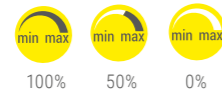

Posiada 3 stopniową regulację natężenia światła.
It has a 3-degree light intensity control.
Es verfügt über eine 3-Grad-Lichtintensitätsregelung.

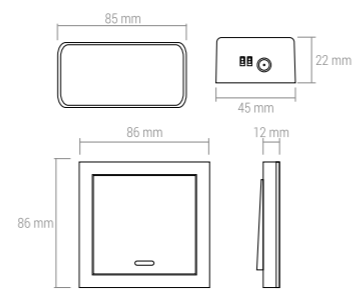
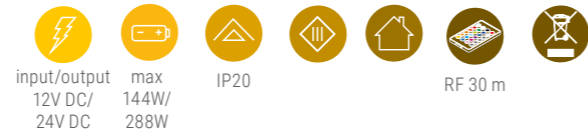

Sterownik RF do oświetlenia jednokolorowego Mono LED w zestawie z wyłącznikiem klawiszowym RF o zasięgu max do 30 m.

RF Controller for single-color Mono LED lighting. Incl. of RF wall mounted switch with max. range up to 30 m. RF-Controller für die einfarbige LED-Beleuchtung mit RF-Schalter mit maximaler Reichweite von bis zu 30 m.

Indeks | Index | Index: STER-KLA-12A-RF-01

170. ZESTAW SELI – STEROWNIK LED MONO RF Z PILOTEM | SELI SET - RF MONO CONTROLLER WITH REMOTE CONTROL | SELI SET - RF-CONTROLLER FÜR DIE EINFARBIGE LED-BELEUCHTUNG MIT RF-FERNBEDIENUNG

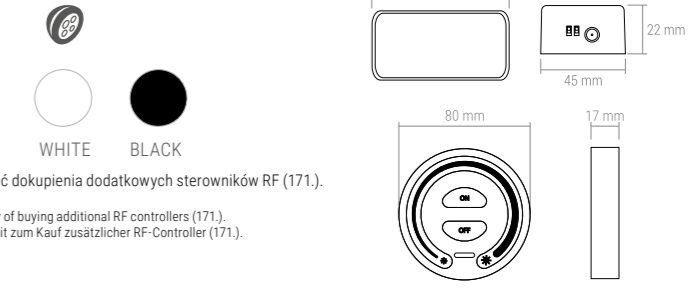

Sterownik RF do oświetlenia jednokolorowego Mono LED w zestawie z pilotem RF o zasięgu max do 30 m działającym również jako wyłącznik i ściemniacz.

RF Controller for single-color Mono LED lighting. Incl. of RF remote control with touch switch and dimmer with max. range up to 30 m. RF-Controller für die einfarbige LED-Beleuchtung mit RF-Fernbedienung mit maximaler Reichweite von bis zu 30 m die auch als Schalter und Dimmer funktioniert.

Możliwość dokupienia dodatkowych sterowników RF (171.).
| Possibility of buying additional RF controllers (171.).
| Möglichkeit zum Kauf zusätzlicher RF-Controller (171.).

Indeks | Index | Index WHITE: SELI-Z-1P-RF-10A-01
BLACK: SELI-Z-1P-RF-10A-CZ-01

171. STEROWNIK SELI LED MONO RF | RF CONTROLLER SELI LED MONO RF | RF-CONTROLLER SELI FÜR DIE EINFARBIGE LED-BELEUCHTUNG

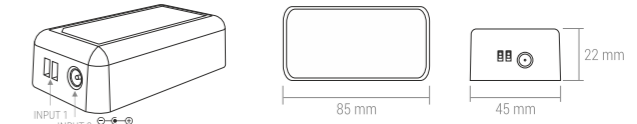

Jeden sterownik RF obsługuje tylko jedną strefę oraz wymaga podłączenia do zasilacza LED.

One RF Controller supports only one zone and requires connection to an LED power supply. Ein RF-Controller unterstützt nur eine Zone und benötigt den Anschluss an eine LED-Stromversorgung.

Indeks | Index | Index: SELI-STER-RF-10A-01

172. ZESTAW OLI – STEROWNIK LED MONO RF I WYŁĄCZNIK ZE ŚCIEMNIACZEM DO OŚWIETLANIA LED | OLI SET - RF MONO CONTROLLER AND SWITCH WITH DIMMER FOR LED LIGHTING | OLI SET - RF-CONTROLLER FÜR DIE EINFARBIGE LED-BELEUCHTUNG UND SCHALTER MIT DIMMER FÜR LED-BELEUCHTUNG



Zeskanuj kod smartfonem i zobacz film jak to działa.
Scan QR code with a smartphone and watch a video of how it works.
Scannen Sie den Code QR mit Ihrem Smartphone und sehen Sie sich das Video an, wie es funktioniert.

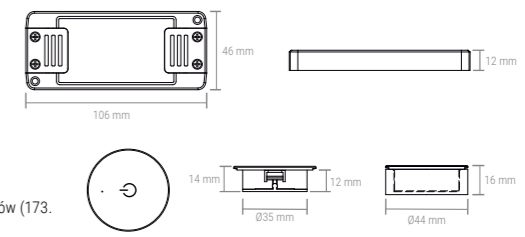

Zestaw zaprogramowany – gotowy do użycia!
| Set already programmed - ready to use!
| SET programmiert - einsatzbereit!

Możliwość rozbudowy zestawu poprzez zakup dodatkowych elementów (173.).
| It is possible to extend the set by purchasing additional elements (173. and 174.).
| Möglichkeit der Erweiterung des Sets durch den Kauf zusätzlicher Elemente (173. und 174.).

Indeks | Index | Index: OLI-ZES-1P-()-01

173. OLI WYŁĄCZNIK-ŚCIEMNIACZ DOTYKOWY LED | OLI LED TOUCH SWITCH DIMMER | OLI LED SCHALTER-BERÜHRUNGS-DIMMER

BLACK WHITE

Battery 2032 IP20

Zeskanuj kod smartfonem i zobacz film jak to działa.

Scan QR code with a smartphone and watch a video of how it works.

Scannen Sie den Code QR mit Ihrem Smartphone und sehen Sie sich das Video an, wie es funktioniert.

Indeks | Index | Index: OLI-SENS-()-01

174. STEROWNIK OLI LED MONO RF | RF CONTROLLER OLI LED MONO RF | RF-CONTROLLER OLI FÜR DIE EINFARBIGE LED-BELEUCHTUNG

BLACK

input/output 12V DC/24V DC output max 8A

IP20 RF 10 m

Zeskanuj kod smartfonem i zobacz film jak to działa.

Scan QR code with a smartphone and watch a video of how it works.

Scannen Sie den Code QR mit Ihrem Smartphone und sehen Sie sich das Video an, wie es funktioniert.

Indeks | Index | Index: OLI-STER-CZ-01

175. ZESTAW DELI 2 – STEROWNIK LED MONO RF Z SENSOREM PIR I ŚCIEMNIACZEM | DELI 2 SET - RF MONO CONTROLLER WITH PIR SENSOR AND DIMMER | DELI 2 SET - RF-CONTROLLER FÜR DIE EINFARBIGE LED-BELEUCHTUNG MIT PIR-SENSOR UND DIMMER

BLACK WHITE

input/output 12V DC/24V DC output max 8A

IP20 RF 10 m

Zestaw zaprogramowany – gotowy do użycia!

| Set already programmed - ready to use! | SET programmiert – einsatzbereit!

Zestaw DELI 2 pozwala na sterowanie oświetleniem do szaf z wieloma drzwiami o zasięgu max do 10 m. Włączanie i wyłączanie oświetlenia następuje automatycznie dzięki sensorowi PIR.

The DELI 2 set allows you to control the lighting for cabinets with multiple doors with max. range up to 10 m. The lighting is switched on and off automatically via a PIR sensor. Mit dem DELI 2-Set können Sie die Beleuchtung in Schränken mit mehreren Türen steuern von bis zu 10 m. Die Beleuchtung wird über einen PIR-Sensor automatisch ein- und ausgeschaltet.

Możliwość dokupienia dodatkowych sensorów PIR (176.).

| Possibility of buying additional RF controllers (176.). | Möglichkeit zum Kauf zusätzlicher RF-Controller (176.).

Indeks | Index | Index: DELI-ZES-1P-()-02

176. DELI 2 SENSOR PIR ZE ŚCIEMNIACZEM | DELI 2 PIR SENSOR WITH DIMMER | DELI 2 PIR-SENSOR MIT DIMMER

BLACK WHITE

Battery IP20

Zeskanuj kod smartfonem i zobacz film jak to działa.

Scan QR code with a smartphone and watch a video of how it works.

Scannen Sie den Code QR mit Ihrem Smartphone und sehen Sie sich das Video an, wie es funktioniert.

Sensor PIR DELI 2 włączy oświetlenie po wykryciu ruchu użytkownika w polu detekcji do 1,5 metra i wyłączy je po około 40 sekundach, jeśli nie wykryje ruchu. Możliwość podłączenia max 4 sensorów PIR do 1 sterownika RF.

The PIR DELI 2 sensor will switch on the lighting when user movement is detected in a detection area of up to 1.5 metres and switches them off after about 40 seconds, if he doesn't detect movement. Up to 4 PIR sensors can be connected to 1 RF controller. Der PIR DELI 2-Sensor schaltet die Beleuchtung ein, wenn eine Bewegung im Bereich von bis zu 1,5 Metern erreicht wird und schaltet sie nach ca. 40 Sekunden wieder ab, wenn er keine Bewegung mehr erkennt. Es können bis zu 4 PIR-Sensoren an einen RF-Controller Langscheidt werden.

Funkcja ściemniania (>1 sek.)

| Dimming function (> 1 sec.) | Dimmfunktion (> 1 Sek.)

Indeks | Index | Index: DELI-SENS-()-02

177. TEO ZESTAW - STEROWNIK RF I WYŁĄCZNIK ZE ŚCIEMNIACZEM | TEO SET - RF CONTROLLER AND SWITCH WITH DIMMER | TEO-SET - RF-CONTROLLER UND SCHALTER MIT DIMMER

BLACK

input/output 12V DC/24V DC output max 8A

IP20 RF 10 m

NOWOŚĆ! NEW! NEU!

Zestaw zaprogramowany – gotowy do użycia!

| Set already programmed - ready to use! | SET programmiert – einsatzbereit!

TEO uniwersalny, bezprzewodowy wyłącznik ze ściemniaczem.

- bezprzewodowe sterowanie oświetleniem LED w meblach;

- dwa tryby pracy wyłącznika do wyboru: 1. DOOR 2. MOVE;

- w systemie drzwi uchylnych, jeden wyłącznik obsługuje dwa skrzydła;

- ściemnianie i rozjaśnianie oświetlenia LED na zbliżenie*;

- bateria ładowana przez port micro USB (5V DC);

- maksymalna moc zestawu 8A (96W/12V DC i 192W/24V DC).

* Dotyczy trybu MOVE

TEO universal, kabellos Schalter mit Dimmer.

- drahtlose Steuerung von LED-Beleuchtung in Möbeln;

- zwei wählbare Schalterbetriebsarten: 1. DOOR 2. MOVE;

- bei einem Flügeltürsystem werden mit einem Schalter zwei Flügel bedient;

- Dimmen und Aufhellen der LED-Beleuchtung bei Annäherung*;

- Akku aufladbar über Micro-USB-Anschluss (5V DC);

- maximale Leistung des Sets 8A (96W/12V DC und 192W/24V DC).

* Gilt für den Betriebsmodus MOVE

Możliwość rozbudowy zestawu poprzez zakup dodatkowych elementów (178.).

| It is possible to extend the set by purchasing additional elements (178.). | Möglichkeit der Erweiterung des Sets durch den Kauf zusätzlicher Elemente (178.).

Zeskanuj kod smartfonem i zobacz film jak to działa.

Scan QR code with a smartphone and watch a video of how it works.

Scannen Sie den Code QR mit Ihrem Smartphone und sehen Sie sich das Video an, wie es funktioniert.

Indeks | Index | Index: TEO-ZES-1P-CZ-01

178. TEO WYŁĄCZNIK ZE ŚCIEMNIACZEM | TEO SWITCH WITH DIMMER | TEO SCHALTER MIT DIMMER

BLACK

Battery IP20

NOWOŚĆ! NEW! NEU!

Indeks | Index | Index: TEO-SENS-CZ-01

179. STEROWNIK / ROUTER WIFI LED | DRIVER / ROUTER WIFI LED | CONTROLLER / ROUTER WIFI LED

input 5V DC IP20

Zeskanuj kod smartfonem i zobacz film jak to działa.

Scan QR code with a smartphone and watch a video of how it works.

Scannen Sie den Code QR mit Ihrem Smartphone und sehen Sie sich das Video an, wie es funktioniert.

Kontroler/Router WiFi umożliwia sterowanie oświetleniem z dowolnego miejsca na świecie bezprzewodowo przez router WiFi za pomocą smartfona lub tabletu (Android lub iOS) po zainstalowaniu darmowej aplikacji.

WiFi controller / router allows you to control the lighting from any location in the world wirelessly over the WiFi router using a smartphone or tablet (Android or iOS) after installing the free application. Der WiFi Controller/Router ermöglicht Ihnen, die Beleuchtung drahtlos über das WiFi-Router mit einem Smartphone oder Tablet (Android oder iOS) nach Installation der kostenlosen Applikation von überall auf der Welt aus steuern.

Sterownik WiFi posiada również timer oraz wsparcie dla asystentów głosowych Amazon Alexa i Google Assistant.

| The WiFi controller also has a timer and support for voice assistants - Amazon Alexa and Google Assistant. | Der WiFi-Controller hat auch einen Timer und Unterstützung für die Sprachassistenten Amazon Alexa und Google Assistant.

Indeks | Index | Index: STER-RGB-WIFI-01



WYŁĄCZNIKI LED

LED SWITCHES
LED SCHALTER

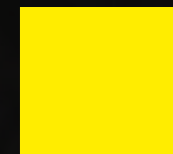

180. WYŁĄCZNIK ZBLIŻENIOWY IR K1 230V | PROXIMITY SWITCH IR K1 230V | NÄHERUNGSSCHALTER IR K1 230V

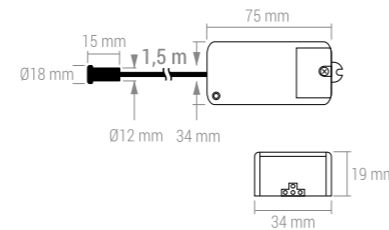

Wyłącznik włącza i wyłącza oświetlenie rejestrując ruch w obszarze 35 mm i kącie 90 stopni.

Ruch w okolicy sensora (do 35 mm) włącza oświetlenie. Ponowny ruch w okolicy sensora wyłącza oświetlenie.

The switch turn the lighting on and off recording movement in the area of 35 mm and 90 degrees angle.
Bewegung um den Sensor (bis zu 35 mm) und einem Winkel von 90 Grad schaltet die Beleuchtung ein und aus.

Movement around the sensor (up to 35 mm) switches on the lighting. A repeated movement around the sensor switches off the lighting.
Eine wiederholte Bewegung um den Sensor schaltet die Beleuchtung aus.

Indeks | Index | Index: WYL-IR-K1-500W

181. WYŁĄCZNIK ZBLIŻENIOWY DO SZAF IR K2 230V | CABINET PROXIMITY SWITCH IR K2 230V | SCHRANK-NÄHERUNGSSCHALTER IR K2 230V

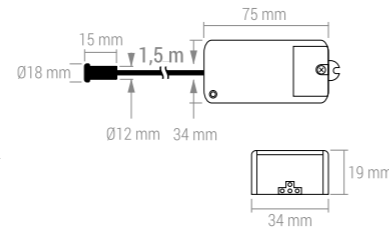

Wyłącznik włącza i wyłącza oświetlenie rejestrując otwarcie i zamknięcie drzwi szafy.

Otwarcie drzwi włącza oświetlenie, zamknięcie drzwi wyłącza oświetlenie.

The switch turn the lighting on and off, recording the opening and closing of the cabinet door.
Der Schalter schaltet die Beleuchtung ein und aus und zeichnet das Öffnen und Schließen der Schranktür auf.

Opening the door switches on the lighting, closing the door switches off the lighting.
Das Öffnen der Tür schaltet die Beleuchtung ein, das Schließen der Tür schaltet die Beleuchtung aus.

Indeks | Index | Index: WYL-IR-K2-500W

182. WYŁĄCZNIK PIR GD500 230V | PIR SWITCH GD500 230V | PIR-SCHALTER GD500 230V

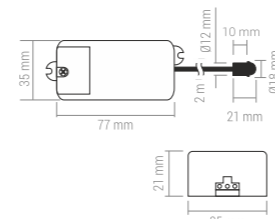

Włącza i wyłącza oświetlenie po wykryciu ruchu w zasięgu czujki PIR w zależności od ustawionego poziomu natężenia światła lub czasu.

Switches the lighting on and off when motion is detected within the range of the PIR detector, depending on the set light intensity level and time setting.
Schaltet die Beleuchtung ein und aus, wenn Bewegungen innerhalb des Bereichs des PIR-Sensor erkannt werden, abhängig von der eingestellten Lichtintensität und Zeiteinstellung.

Indeks | Index | Index: WYL-PIR-GD500-01

183. WYŁĄCZNIK ZMIERZCHOWY - Z1 | LIGHT CONTROL SENSOR - Z1 | DÄMMERUNGSSCHALTER - Z1

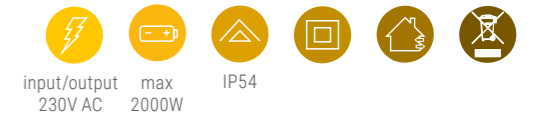

IP54

Wyłącznik zmierzchowy służy do automatycznego załączania oświetlenia o zmierzchu i wyłączenia go o świcie. Wyłącznik przeznaczony jest do zabudowania w obudowie finalnej, stopień IP54 dotyczy samego sensora.

Light control sensor is used to automatically switch on the lighting at twilight and turn off at daylight. The switch is designed to be built-in in the final case/ box, the IP54 degree is only for sensor.
Der Dämmerungsschalter dient zum automatischen Ein- und Ausschalten der Beleuchtung bei Dämmerung. Der Schalter ist für den Einbau in ein Endgehäuse vorgesehen, die Schutzart IP54 gilt für den Sensor selbst.

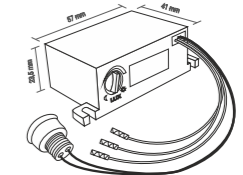

Indeks | Index | Index: WYL-Z-Z1-01

184. WYŁĄCZNIK DOTYKOWY DBT 230V | TOUCH SWITCH DBT 230V | BERÜHRUNGSSCHALTER DBT 230V

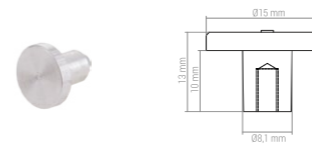
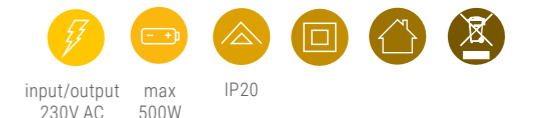

OP2-GRZ-FI15-ALU-01W
Grzybek sensor dotykowy fi 15 mm z wkrętem m3x3

Touch sensor fi 15 mm with screw m3x3
Pilz-Tastensensor fi 15 mm mit Schraube m3x3

Sensor dotykowy należy zamontować do metalowego elementu, aczkolwiek nie może to być profil aluminiowy, w którym zamontowana jest taśma LED.

The touch sensor should be mounted to a metal element, however, it can not be an aluminum profile in which the LED strip is mounted.
Montieren Sie den Berührungssensor an ein Metallelement, jedoch darf es nicht das Aluminiumprofil sein, in dem das LED Band montiert ist.

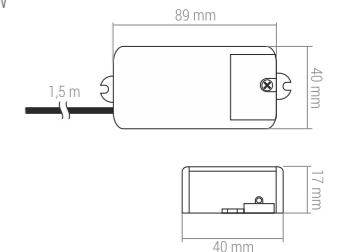

Indeks | Index | Index: WYL-DBT-01

185. WYŁĄCZNIK Z PODŚWIETLENIEM LED | BACKLIGHT SWITCH LED | SCHALTER MIT BELEUCHTUNG LED



IP67

Wyłącznik wyposażony w podświetlenie LED w kolorze zielonym. Możliwość stosowania w miejscach z podwyższoną wilgotnością.

Switch equipped with green LED backlight. Can be used in places with increased humidity.
Schalter mit grüner LED-Hintergrundbeleuchtung. Kann an Orten mit erhöhter Luftfeuchtigkeit eingesetzt werden.

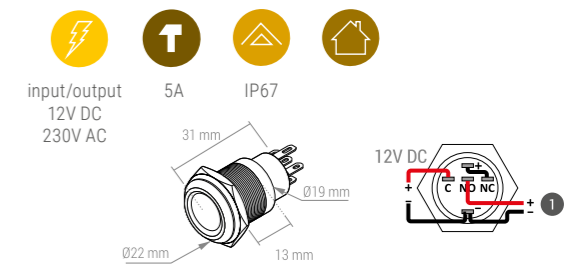

1. Oświetlenie | Light | Beleuchtung

Indeks | Index | Index: WYL-WAND-19-LED-GR

186. WYŁĄCZNIK MEBLOWY Z DYSTANSEM WM230 | FURNITURE SWITCH WITH DISTANCE WM230 | MÖBELSCHALTER MIT ABSTAND WM230



Posiada 2 m przewód zasilający
| 2 m input cable
| 2 m langes Netzkabel

AL

input/output 12V DC/230V AC max 2,5A IP20

1. Oświetlenie | Light | Beleuchtung

Indeks | Index | Index: WYL-WM230-D-01

187. WYŁĄCZNIK MEBLOWY DO WPUSTU WM230 | RECESSED SWITCH WM230 | MÖBELEINLASSSCHALTER WM230



Posiada 2 m przewód zasilający
| 2 m input cable
| 2 m langes Netzkabel

AL

input/output 12V DC/230V AC max 2,5A IP20 Ø 55 mm

1. Oświetlenie | Light | Beleuchtung

Indeks | Index | Index | Индекс: WYL-WM230-W-01

188. WYŁĄCZNIK ZBLIŻENIOWY IR S01 | INFRARED MOTION SENSOR SWITCH IR S01 | NÄHERUNGSSCHALTER IR S01



BLACK WHITE

input/output 12V DC 24V DC max 24W 48W IP20 mini konektor IR max Ø 14 mm 10 cm

1. REGULACJA: A. Wyłącznik ogólny; B. Wyłącznik do szaf
1. Switch set up: A. Bistable mode; B. Monostable mode
1. Regulierung: A. Betriebsart Bistabil; B. Betriebsart Monostabil

Indeks wyłącznik | Index switch | Index Schalter: WYL-IR-S01-24W-()
Indeks uchwyt | Index bracket | Index Halterung: OP2-UCHWYT-S01-()-01

Uchwyt należy dokupić osobno
| The bracket can be bought separately
| Halter muss separat erworben werden

Wyłłącznik do oświetlenia LED z możliwością regulacji trybu działania pomiędzy trybami IR bistabilnym i IR monostabilnym.
Schalter für LED-Beleuchtung mit einstellbarer Betriebsart zwischen bistabilen und monostabilen IR-Mode.

ON/OFF

189. WYŁĄCZNIK-ŚCIEMNIACZ DOTYKOWY LED | LED TOUCH SWITCH DIMMER | LED SCHALTER-BERÜHRUNGSDIMMER



BLACK WHITE

input/output 12V DC 24V DC max 36W 72W IP20 mini konektor Ø 18 mm

Wyłącznik dotykowy
| Touch switch
| Berührungsschalter

Indeks | Index | Index: WYL-SENS-36W-()-02

190. WYŁĄCZNIK-ŚCIEMNIACZ DOTYKOWY LED | LED TOUCH SWITCH DIMMER | LED SCHALTER-BERÜHRUNGSDIMMER



CH

input/output 12V DC 24V DC max 36W 72W IP20 mini konektor Ø 15 mm

Wyłącznik dotykowy
| Touch switch
| Berührungsschalter

Zeskanuj kod smartfonem i zobacz film jak to działa.
Scan QR code with a smartphone and watch a video of how it works.
Scannen Sie den Code QR mit Ihrem Smartphone und sehen Sie sich das Video an, wie es funktioniert.

Włącza-wyłącza oświetlenie za pomocą dotyku.
| Turns on/off lighting by touching the sensor.
| Schaltet die Beleuchtung mit Hilfe einer Berührung.

Posiada funkcję ściemniania lub rozjaśniania.
| It has the function of light dimming or brightening.
| Enthält Dimmfunktionen.

Indeks | Index | Index: WYL-SENS-36W-CH-02

191. WYŁĄCZNIK-ŚCIEMNIACZ PRZYCISKOWY LED W01 | LED MECHANICAL SWITCH DIMMER W01 | LED DRUCKSCHALTER MIT DIMMER W01



BLACK WHITE

input/output 12V DC max 36W IP20 mini konektor Ø 14 mm

Krótkie przyciśnięcie włączy/wyłączy oświetlenie, dłuższe – ściemni/rozjaśni.
| A short touch will turn on/off the lighting, longer – dim/brighten.
| Kurzer Tastendruck schaltet die Beleuchtung ein/aus, langer Tastendruck – dimmt/hellt auf.

Indeks | Index | Index: WYL-W01-()-01

192. WYŁĄCZNIK-ŚCIEMNIACZ PRZYCISKOWY LED W02 | LED MECHANICAL SWITCH DIMMER W02 | LED DRUCKSCHALTER MIT DIMMER W02



ON/OFF

Wyłącznik wyposażony w podświetlenie LED w kolorze niebieskim.
| Blue backlight.
| Blaue Hintergrundbeleuchtung.

Krótkie przyciśnięcie włączy/wyłączy oświetlenie, dłuższe – ściemni/rozjaśni.
| A short touch will turn on/off the lighting, longer – dim/brighten.
| Kurzer Tastendruck schaltet die Beleuchtung ein/aus, langer Tastendruck – dimmt/hellt auf.

CH

- input/output 12V DC
- max 36W
- IP20
- mini konektor
- Ø35 mm

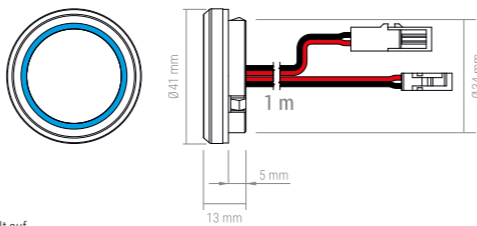

Indeks | Index | Index: WYL-W02-CH-01

193. WYŁĄCZNIK SENSOROWY LT36 | SENSOR SWITCH LT36 | SENSORSCHALTER LT36



ON/OFF

Włącza-wyłącza oświetlenie za pomocą dotyku.
| Turns on/off lighting by touching the sensor.
| Schaltet die Beleuchtung mit Hilfe einer Berührung.

Posiada funkcję ściemniania lub rozjaśniania.
| It has the function of light dimming or brightening.
| Enthält Dimmfunktionen.

AL

- input/output 12V DC
- max 36W
- 24V DC
- 72W
- IP20
- mini konektor



Indeks | Index | Index: WYL-LT36-AL-01

194. WYŁĄCZNIK PIR DO SZAF | CABINET PIR SWITCH | SCHRANKSCHALTER PIR



Jeżeli w zasięgu ok. 1,5 m wyłącznik wykryje ruch to włączy oświetlenie. Po czasie 40 s od momentu kiedy wyłącznik nie wykrywa żadnego ruchu, oświetlenie zostanie wyłączone.
If the switch detects movement within a range of approx. 1.5 m, the lighting will turn on. After 40 seconds from the moment when the switch does not detect any movement, the lighting will be switched off.
Erkennt der Schalter eine Bewegung in einem Bereich von ca. 1,5 m, schaltet er die Beleuchtung ein. Nach 40 Sekunden ab dem Moment, in dem der Schalter keine Bewegung erkennt, wird die Beleuchtung ausgeschaltet.

input/output 12V DC

max 24W

24V DC

48W

IP20

mini konektor

PIR max 1,5 m



Indeks | Index | Index: WYL-PIR-SZ-S03

195. WYŁĄCZNIK ZBLIŻENIOWY IR OŚWIETLENIE LED DO SZAF DOOR | IR SWITCH FOR LED LIGHTING FOR CABINETS | NÄHERUNGSSCHALTER IR FÜR LED-SCHRANKBELEUCHTUNG



Zeskanuj kod smartfonem i zobacz film jak to działa.
Scan QR code with a smartphone and watch a video of how it works.
Scannen Sie den Code QR mit Ihrem Smartphone und sehen Sie sich das Video an, wie es funktioniert.

input/output 12V DC

max 36W

24V DC

72W

IP20

mini konektor

IR max 15 cm

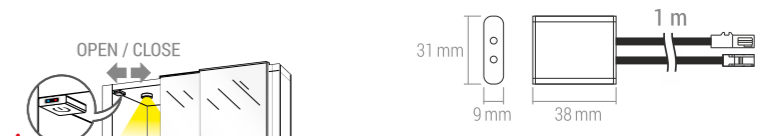

Indeks | Index | Index: WYL-IRS-AL-01

196. WYŁĄCZNIK ZBLIŻENIOWY IR DO LED MOVE | IR SWITCH FOR LED LIGHTING | NÄHERUNGSSCHALTER IR LED



Zeskanuj kod smartfonem i zobacz film jak to działa.
Scan QR code with a smartphone and watch a video of how it works.
Scannen Sie den Code QR mit Ihrem Smartphone und sehen Sie sich das Video an, wie es funktioniert.

input/output 12V DC

max 36W

24V DC

72W

IP20

mini konektor

IR max 15 cm

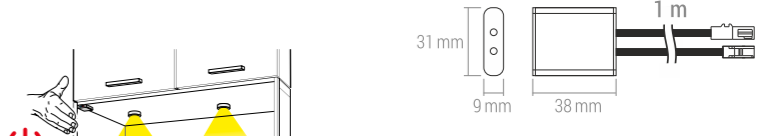

Indeks | Index | Index: WYL-WRS-AL-01

197. WYŁĄCZNIK DOTYKOWY ZE ŚCIEMNIACZEM DO LED TOUCH | TOUCH SWITCH FOR LED LIGHTING WITH DIMMER | BERÜHRUNGSSCHALTER LED MIT DIMMFUNKTION



Zeskanuj kod smartfonem i zobacz film jak to działa.
Scan QR code with a smartphone and watch a video of how it works.
Scannen Sie den Code QR mit Ihrem Smartphone und sehen Sie sich das Video an, wie es funktioniert.

input/output 12V DC

max 36W

24V DC

72W

IP20

mini konektor

Posiada funkcję ściemniania lub rozjaśniania. Długi dotyk wyłącznika aktywuje funkcję ściemniacza.
It has the function of dimming or brightening. Long touch of the switch activates the dimmer.
Er hat eine Dimm- oder Aufhellfunktion. Ein langer Druck auf den Schalter aktiviert die Dimmerfunktion.

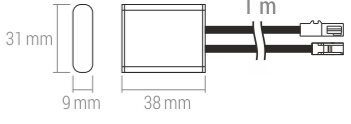

Indeks | Index | Index: WYL-TDS-AL-01

198. ZESTAW Z ZASILACZEM 38W I WYŁĄCZNIKIEM POJEMNOŚCIOWYM | SET 38W WITH CAPACITIVE SWITCH
| SET MIT NETZTEIL 38W UND BERÜHRUNGSSCHALTER



Zestaw dotykowy do oświetlenia LED o mocy sumarycznej nie przekraczającej 36W. Wyposażony w wyłącznik pojemnościowy CS.

Touch SET for LED lighting with a total capacity not exceeding 36W. Equipped with capacitive switch CS. Berührungsschalter zur LED Beleuchtung mit der maximalen Gesamtleistung von 36W. Das Set ist mit Berührungsschalter CS ausgerüstet.

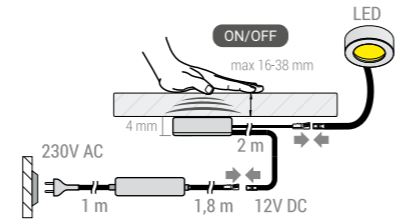

Indeks | Index | Index: Z-CT-PLD38-02W

199. WYŁĄCZNIK PRZYCISKOWY MS60 DO PROFILI | TOUCH SWITCH MS60 FOR PROFILES | DRUCKSCHALTER MS60 FÜR PROFILE

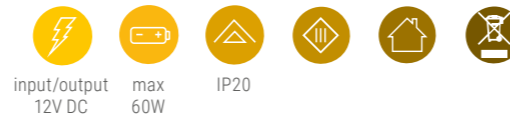
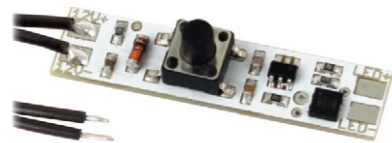

Płytki posiada wbudowany wyłącznik przyciskowy. Wystarczy zamontować wyłącznik i wykonać otwór w kloszu o średnicy 4 - 5 mm.

The plate has a built-in mechanical switch. Simply mount the switch and make a hole in the cover with a diameter of 4 - 5 mm. Die Platte hat einen eingebauten mechanischen Schalter. Einfach den Schalter montieren und ein Loch in die Abdeckung mit einem Durchmesser von 4 - 5 mm machen.

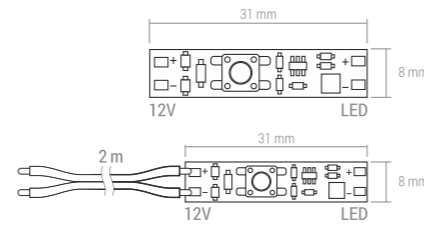

Pasuje do profili | Fits to profiles | Passt zu Profilen: LINE MINI, INLINE MINI, INLINE MINI XL, TRI-LINE MINI, CORNER LINE.

Indeks | Index | Index: WYL-MS60-01W
 Indeks wersja z 2 m przewodem | Index version with 2 m cable
 | Index Variante mit 2 m Kabel: WYL-MS60-02W

200. WYŁĄCZNIK DOTYKOWY XC60 DO PROFILI | TOUCH SWITCH XC60 FOR PROFILES | TOUCH SCHALTER XC60 FÜR PROFILE

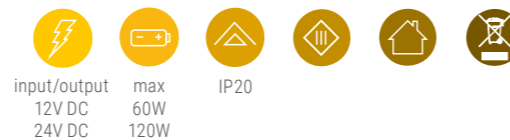
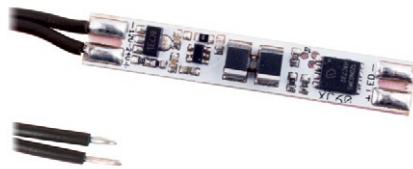

Wyłącznik do montażu w profilach LED posiada podświetlenie ułatwiające korzystanie z funkcji włącz/wyłącz.

The switch for mounting in LED profiles has a backlight to facilitate the use of the on/off function. Der Schalter für den Einbau in LED-Profilen hat eine Hintergrundbeleuchtung, die die Nutzung der Ein/Aus-Funktion erleichtert.

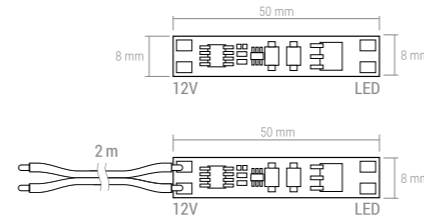

Pasuje do profili | Fits to profiles | Passt zu Profilen: LINE MINI, INLINE MINI, INLINE MINI XL, TRI-LINE MINI, CORNER LINE.

Indeks | Index | Index: WYL-XC60-NI-01W
 Indeks wersja z 2 m przewodem | Index version with 2 m cable
 | Index variante mit 2 m Kabel: WYL-XC60-NI-02W

201. WYŁĄCZNIK DOTYKOWY Z FUNKCJĄ ŚCIEMNIANIA SC60 DO PROFILI | TOUCH SWITCH SC60 WITH DIMMING FUNCTION FOR PROFILES | TOUCH SCHALTER SC60 MIT DIMMFUNKTION FÜR PROFILE

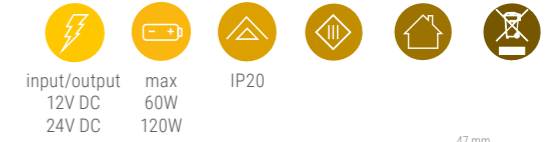
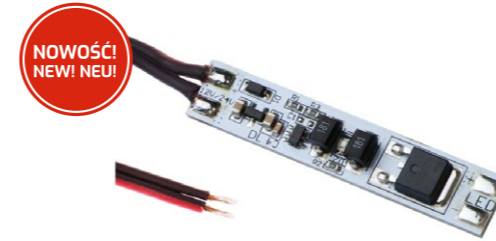

Wyłącznik do montażu w profilach LED posiada podświetlenie ułatwiające korzystanie z funkcji włącz/wyłącz oraz ściemnij/rozjaśnij.

The switch for mounting in LED profiles has a backlight to facilitate the use of the on/off and dimming function. Der Schalter für den Einbau in LED-Profilen hat eine Hintergrundbeleuchtung, die die Nutzung der Ein/Aus-Funktion und Dimmfunktion erleichtert.

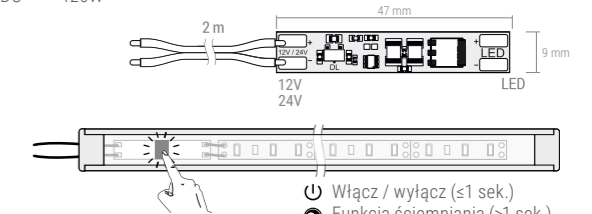

Pasuje do profili | Fits to profiles | Passt zu Profilen: LINE MINI, INLINE MINI, INLINE MINI XL, CORNER LINE.

Włącz / wyłącz (≤ 1 sek.)
 Funkcja ściemniania (> 1 sek.)
 ON / OFF (≤ 1 sec.)
 Dimming function (> 1 sec.)
 ON / OFF (≤ 1 Sek.)
 Dimmfunktion (> 1 Sek.)

Indeks wersja z 2 m przewodem | Index version with 2 m cable
 | Index variante mit 2 m Kabel: WYL-SC60-NI-02

202. WYŁĄCZNIK ZBLIŻENIOWY RUMMY DO PROFILI | PROXIMITY SWITCH RUMMY FOR PROFILES | NÄHERUNGSSCHALTER RUMMY FÜR PROFILE

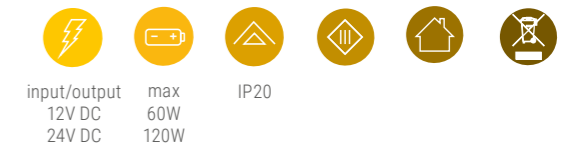
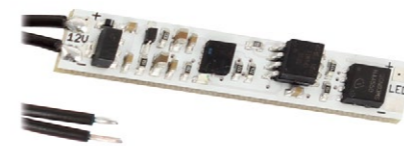

Wyłącznik działa przez klosz w profilu LED. Maksymalny zakres pracy do 3 cm.

The switch operates through a diffuser in the LED profile. Maximum working range up to 3 cm. Der Schalter arbeitet über einen Diffusor im LED-Profil. Maximaler Arbeitsbereich bis 3 cm.

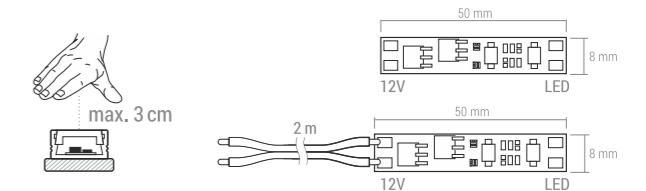

Pasuje do profili | Fits to profiles | Passt zu Profilen: LINE MINI, INLINE MINI, INLINE MINI XL, CORNER LINE.

Indeks | Index | Index: WYL-IR-RUMMY-01W
 Indeks wersja z 2 m przewodem | Index version with 2 m cable
 | Index variante mit 2 m Kabel: WYL-IR-RUMMY-02W

203. WYŁĄCZNIK IR KX60 DO PROFILI | IR SWITCH/PLATE KX60 FOR LED PROFILES | IR SCHALTER KX60 FÜR LED PROFILE

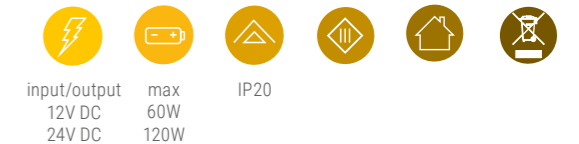

Wyłącznik działa przez klosz w profilu LED. Maksymalny zakres pracy do 3 cm.

The switch operates through a diffuser in the LED profile. Maximum working range up to 3 cm. Der Schalter arbeitet über einen Diffusor im LED-Profil. Maximaler Arbeitsbereich bis 3 cm.

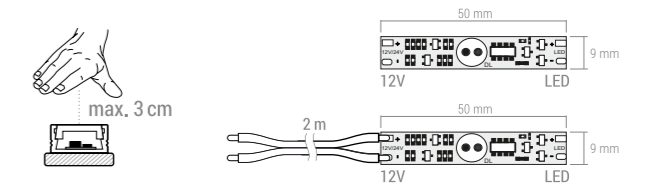

Pasuje do profili | Fits to profiles | Passt zu Profilen: LINE MINI, INLINE MINI, INLINE MINI XL, CORNER LINE.

Indeks wersja z 2 m przewodem | Index version with 2 m cable
 | Index variante mit 2 m Kabel: WYL-KX60-IR-02

204. UNIWERSALNY WYŁĄCZNIK Z PODŚWIETLENIEM, DOTYKOWY MASTER | UNIVERSAL TOUCH SWITCH WITH BACKLIGHTING MASTER | UNIVERSELLER BERÜHRUNGSSCHALTER MIT HINTERGRUNDBELEUCHTUNG MASTER



Wyłącznik dotykowy do oświetlenia LED z podświetleniem punktu włącz/ wyłącz Kompatybilny ze wszystkimi produktami LED w systemie okablowanie mini konektor.

Touch switch for LED lighting with highlighted point on/off Compatible with all LED products with the mini connector cable system.
Berührungsschalter für LED-Beleuchtung mit Ein/Aus-Punkt-Beleuchtung Kompatibel mit allen LED-Produkten im System Mini-Steckerverbindung.



input/output
12V DC
24V DC

max
36W
72W

IP20

mini konektor

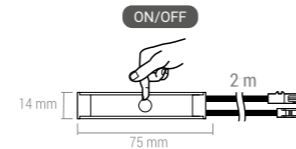

Indeks | Index | Index: WYL-CT-BI-V16-01W

205. ŚCIEMNIACZ RF Z PRZEWODEM LUB ROZDZIELACZEM | LED MONO CONTROLLER/DIMMER WITH RF REMOTE | DIMMER RF MIT KABEL ODER VERTEILER



Zeskanuj kod smartfonem i zobacz film jak to działa.

Scan QR code with a smartphone and watch a video of how it works.
Scannen Sie den Code QR mit Ihrem Smartphone und sehen Sie sich das Video an, wie es funktioniert.



input/output
12V DC
24V DC

max
72W
144W

IP20

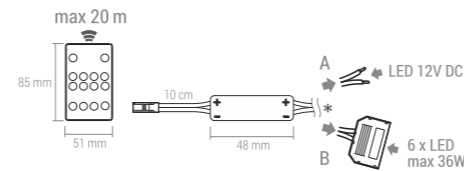

Indeks A | Index A | Index A: STER-MONO-RF-02
Indeks B | Index B | Index B: STER-MONO-RF6-02

Ściemniacz służy do ustawiania poziomu jasności oświetlenia LED za pomocą pilota radiowego o zasięgu do 20 m. Posiada płynną lub skokową regulację jasności oraz tryb FUN z efektem migania światła.

The dimmer is used to set the LED brightness level by means of a radio remote control with a range of up to 20 m. It has smooth or stepless brightness adjustment and FUN mode with flashing light effect.
Der Dimmer dient zur Einstellung der LED-Helligkeit mittels einer Funkfernbedienung mit einer Reichweite von bis zu 20 m. Er verfügt über eine stufenlose oder stufenlose Helligkeitseinstellung und einen FUN-Modus mit Blinklichteffekt.

206. ŚCIEMNIACZ RF Z PILOTEM | RF LED DIMMER WITH WIRELESS REMOTE | RF LED DIMMER MIT FERNBEDIENUNG



Zeskanuj kod smartfonem i zobacz film jak to działa.

Scan QR code with a smartphone and watch a video of how it works.
Scannen Sie den Code QR mit Ihrem Smartphone und sehen Sie sich das Video an, wie es funktioniert.



input/output
12V DC
24V DC

max
96W
192W

IP20

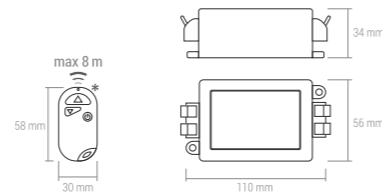

Indeks | Index | Index: STER-1xGNI-8A-RF-01

Ściemniacz służy do ustawiania poziomu jasności oświetlenia LED za pomocą pilota radiowego.

The dimmer is used to adjust the brightness level of the LED lighting using the radio remote control.
Mit dem Dimmer wird die Helligkeit der LED-Beleuchtung über die Funkfernbedienung eingestellt.

207. WYŁĄCZNIK NOŻNY | FOOT SWITCH | FUSSSCHALTER



BLACK



230V AC



2A



IP20

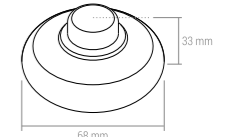

Indeks | Index | Index: WYL-NOZNY-CZAR-ZMON

208. WYŁĄCZNIK KOŁYSKOWY W11 | SWITCH W11 | SCHALTER W11



BLACK WHITE



BROWN GREY



230V AC



6A



IP20



Ø21 mm

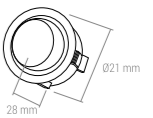

Indeks | Index | Index: WYL-KOLY-W11.1-()

209. WYŁĄCZNIK KORALIKOWY | BEADS SWITCH | KETTENSCHALTER



CH



230V AC



3A



IP20

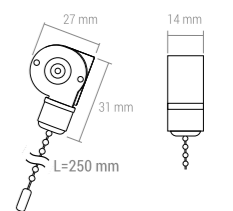

Indeks | Index | Index: WYL-KOR-CHROM





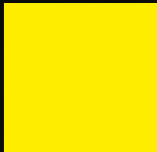

**PRZEWODY
- ŹRÓDŁA
ŚWIATŁA**

**CABLES
- LIGHT SOURCES
KABEL
- LICHTQUELLEN**





210. PRZEWÓD 2 X 0,75 MM² Z WTYCZKĄ EURO | CABLE 2 X 0,75 MM² WITH EURO PLUG | NETZKABEL 2 X 0,75 MM² MIT EUROSTECKER

Kolor Color Farbe	Biały White Weiß	Czarny Black Schwarz	Biały White Weiß	Czarny Black Schwarz	Biały White Weiß	Czarny Black Schwarz
Dł. przewodu Cable Length Kabellänge	2 m	2 m	3 m	3 m	5 m	5 m

Indeks | Index | Index: PRZ-(m)-2x0,75-()

211. PRZEWÓD 2 X 0,75 MM² Z WTYCZKĄ EURO I WYŁĄCZNIKIEM | CABLE 2 X 0,75 MM² WITH EURO PLUG AND PC1 SWITCH | NETZKABEL 2 X 0,75 MM² MIT EUROSTECKER UND SCHALTER



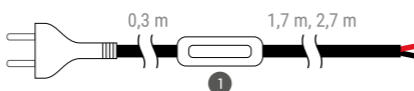





1. Wyłącznik na przewodzie
Switch | Schalter

Kolor Color Farbe	Biały White Weiß	Czarny Black Schwarz	Biały White Weiß	Czarny Black Schwarz
Dł. przewodu Cable Length Kabellänge	2 m	2 m	3 m	3 m

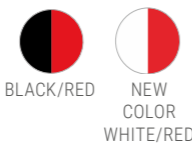
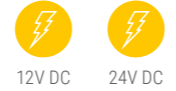
Indeks | Index | Index: PRZ-(m)-PC1-()



212. PRZEWÓD DO LED NA METRAŻ 2 X 0,35 MM² | LED CABLE PER METER 2 X 0,35 MM² | LED NETZKABEL METERWARE 2 X 0,35 MM²

Ilość w opakowaniu zbiorczym 100 mb
The quantity in a roll 100 mb | Die Menge in der Verpackung (rolle) 100 mb

Indeks | Index | Index: PRZ-MET-2x0,35-()

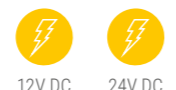

213. PRZEWÓD DO LED NA METRAŻ 2 X 0,5 MM² | LED CABLE PER METER (2 X 0,5 MM²) | LED NETZKABEL METERWARE 2 X 0,5 MM²

Ilość w opakowaniu zbiorczym 100 mb
The quantity in a roll 100 mb | Die Menge in der Verpackung (rolle) 100 mb

Indeks | Index | Index: PRZ-MET-2x0,50-()

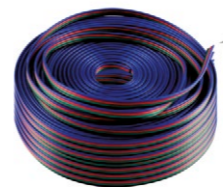

214. PRZEWÓD DO RGB NA METRAŻ 4 X 0,32 MM² | LED CABLE RGB PER METER (4 X 0,32 MM²) | LED NETZKABEL RGB METERWARE 4 X 0,32MM²

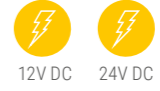
Ilość w opakowaniu zbiorczym 100 mb
The quantity in a roll 100 mb | Die Menge in der Verpackung (rolle) 100 mb

Indeks | Index | Index: PRZ-MET-4x0,32-CZ

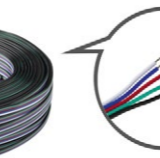

215. PRZEWÓD DO RGBW NA METRAŻ 5 X 0,32 MM² | LED CABLE RGBW PER METER (5 X 0,32 MM²) | LED NETZKABEL RGBW METERWARE 5 X 0,32MM²

Ilość w opakowaniu zbiorczym 100 mb
The quantity in a roll 100 mb | Die Menge in der Verpackung (rolle) 100 mb

Indeks | Index | Index: PRZ-MET-5x0,32-CZ

216. PRZEWÓD DO 230V NA METRAŻ 2 X 0,75 MM² | 230V CABLE PER METER 2 X 0,75MM² | 230V NETZKABEL METERWARE 2 X 0,75MM²

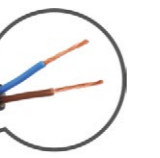
Ilość w opakowaniu zbiorczym 100 mb
The quantity in a roll 100 mb | Die Menge in der Verpackung (rolle) 100 mb

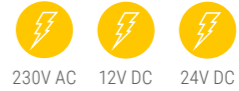
Indeks | Index | Index: PRZ-MET-2x0,75-()

217. ŻARÓWKA 5W GU10 LED | GU10 LIGHT BULB 5W LED | LAMPE GU10 5W LED

Indeks | Index | Index: ZAR-D-G-5W-01-()

Parametry źródła światła | Light source parameters | Parameter der Lichtquelle:

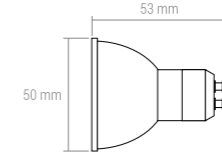
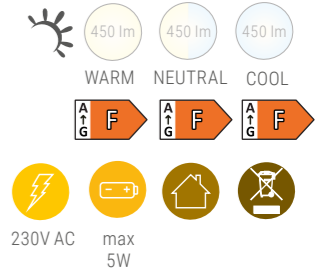

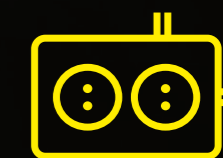

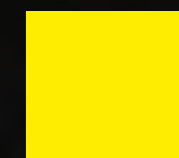

PRZEDŁUŻACZE
- GNIAZDA
EXTENSION POWER
SOCKETS
STECKDOSEN



218. CORNER BOX 2 USB



AL WHITE BLACK

input/output max 230V AC 3600W

USB input 5V DC max 2,1A

IP20

1,8 m 2 x USB

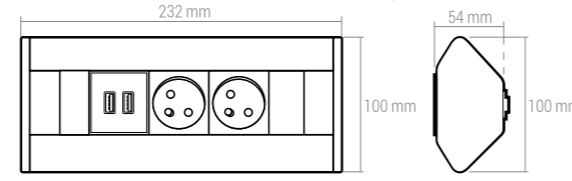

Indeks | Index | Index 2 x FRENCH TYPE, 2 x USB AL : CORNERBOX-ALU-2FR-U
Indeks | Index | Index 2 x SCHUKO, 2 x USB AL: CORNERBOX-ALU-2DE-U
WHITE: CORNERBOX-BI-2DE-U
BLACK: CORNERBOX-CZ-3DE-U
Indeks | Index | Index 2 x UK TYPE, 2 x USB AL: CORNERBOX-ALU-2UK-U

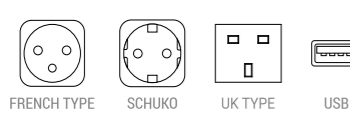

221. CORNER BOX 2G + 1W



AL

input/output max 230V AC 3600W

IP20

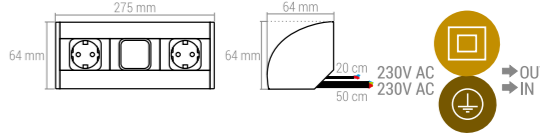

Indeks | Index | Index: CORNER-ALU-2G1W-DE-1

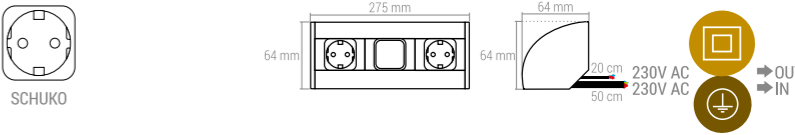

219. CORNER BOX 3



AL WHITE BLACK

input/output max 230V AC 3600W

IP20

1,8 m

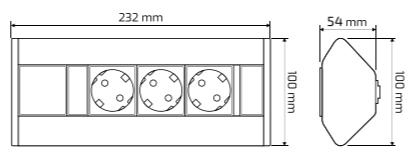

Indeks | Index | Index 3 x FRENCH TYPE AL: CORNERBOX-ALU-3FR
Indeks | Index | Index 3 x SCHUKO AL: CORNERBOX-ALU-3DE
WHITE: CORNERBOX-BI-3DE
BLACK: CORNERBOX-CZ-3DE
Indeks | Index | Index 3 x UK TYPE AL: CORNERBOX-ALU-3UK

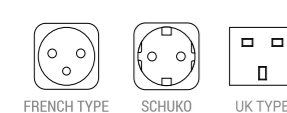

222. CORNER BOX 2G



AL

input/output max 230V AC 3600W

IP20

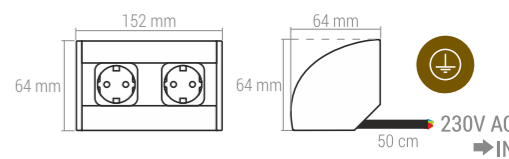

Indeks | Index | Index: CORNER-ALU-2G-DE-1

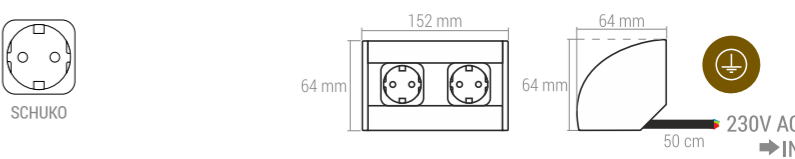

220. CORNER BOX 4



AL

input/output max 230V AC 3600W

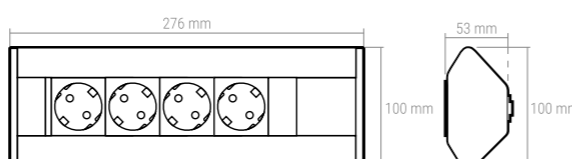

IP20

1,8 m

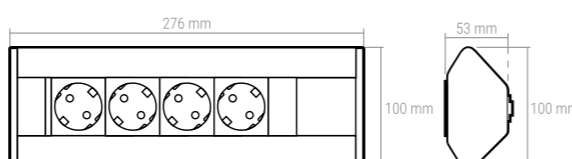

Indeks | Index | Index: CORNERBOX-ALU-4DE

Uniwersalny montaż! Cornerbox można zamontować: w narożu, na blacie lub podszafkowo.
 | Universal installation! Cornerbox can be installed at a corner, on a worktop or under the shelf.
 | Universeller Einbau! Die Cornerbox kann in einer Ecke, auf einer Arbeitsplatte oder unter dem Schrank montiert werden.

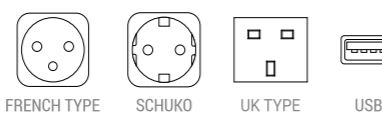
223. CORNER BOX 1G + 1W



AL

input/output max 230V AC 3600W

IP20

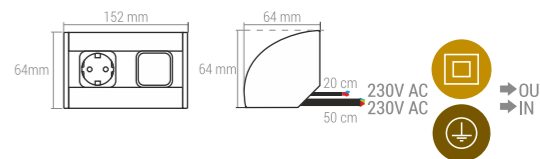

Indeks | Index | Index: CORNER-ALU-1G1W-DE-1

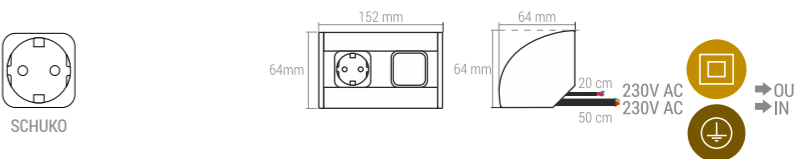

224. MINI BOX SCHUKO



AL



SCHUKO



input/output max
230V AC 3600W

IP20

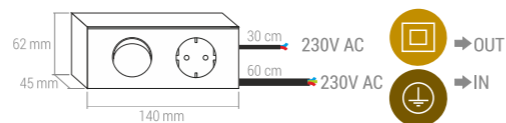

Indeks | Index | Index: KOMBIBOX-SCHU-06

1 x SCHUKO 16A
1 x WŁĄCZNIK | Switch | Schalter

225. DESK BOX

NOWOŚCI
NEW! NEU!



STDR



input/output max
230V AC 3600W

USB input max
5V DC 2,4A

IP20

2 x USB

1,8 m

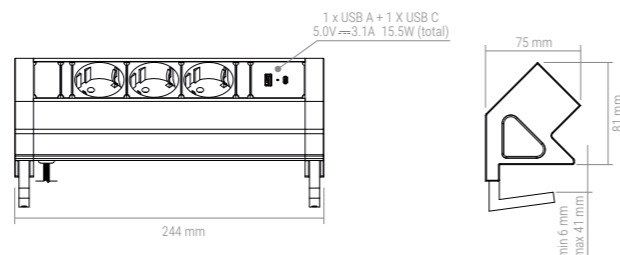

Indeks | Index | Index 3 x FRENCH TYPE, 2 x USB: DESKBOX-SD-3FR-UAC-01
Indeks | Index | Index 3 x SCHUKO, 2 x USB: DESKBOX-SD-3DE-UAC-01

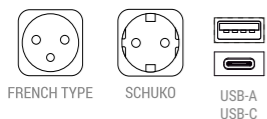

226. GNIAZDO Z WYŁĄCZNIKIEM I KLAPKĄ | SOCKET WITH SWITCH AND FLAP | MÖBELSTECKDOSE MIT SCHALTER UND KLAPPE

IP44



WHITE



SCHUKO



input/output max
230V AC 3600W

IP44

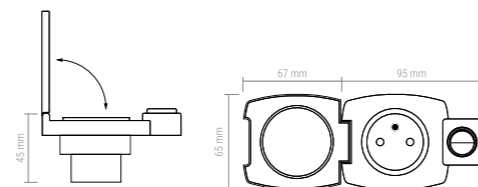

Indeks | Index | Index: GNI-M-KL-SCH-BI-01

1 x SCHUKO 16A

227. KOMBI BOX Z 1,5 M/ 3M PRZEWODEM I WTYCZKĄ Z UZIEMIENIEM | KOMBI BOX WITH 1,5 M/ 3M POWER CABLE AND PLUG WITH ELECTRICAL GROUNDING | KOMBI BOX MIT 1,5 M/ 3M KABEL UND ERDUNGSSTECKER



AL

BLACK

WHITE



input/output max
230V AC 3600W

IP20

1,5 m 224x109 mm
3 m

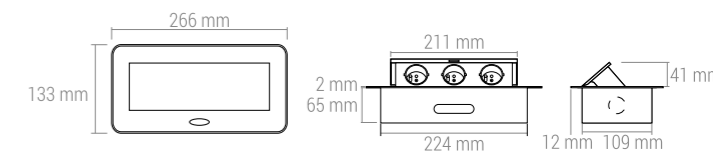

- Przewód 1,5 x 1,5 mm².
| Power cable 1,5 x 1,5 mm². | Kabel 1,5 x 1,5 mm².
- Wtyczka z uziemieniem.
| Plug with electrical grounding. | Erdungsstecker.

- Przewód 3 x 1,5 mm².
| Power cable 3 x 1,5 mm². | Kabel 3 x 1,5 mm².
- Wtyczka z uziemieniem.
| Plug with electrical grounding. | Erdungsstecker.

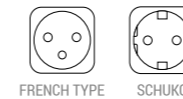

Indeks | Index | Index 3 x FRENCH TYPE, 1,5 m: KOMB-()-FR-1,5-M02

Indeks | Index | Index 3 x SCHUKO, 1,5 m: KOMB-()-DE-1,5-M01W

Indeks | Index | Index 3 x FRENCH TYPE, 3 m: KOMB-()-FR-3,0-M02

Indeks | Index | Index 3 x SCHUKO, 3 m: KOMB-()-DE-M01W



1. 3 wersje kolorystyczne: aluminium, czarny i biały. | 3 colors versions: aluminium, black and white. | 3 Farbvarianten: aluminium, schwarz und weiß.

2. Nowoczesny i ergonomiczny design. Delikatne, fazowane krawędzie idealnie przylegają do blatu meblowego. | The modern and ergonomic design. Delicate, beveled edges perfectly adhere to the furniture surface. | Das moderne und ergonomische Design. Sanft abgeschragte Kanten passen sich der Arbeitsplatte perfekt an.

3. Bezpieczeństwo użytkownika. Gniazda 16A z uziemieniem oraz przewody o przekroju 1,5 mm². | User safety. 16A grounded French sockets and wires cross section of 1,5 mm². | Benutzersicherheit. 16A Steckdose mit Erdung und Kabelabschnitt 1,5 mm².

4. Jakość wykonania. Mocna obudowa chroniąca przewody przed uszkodzeniami mechanicznymi w 3 wersjach kolorystycznych. | High quality. Durable case protecting the wires against mechanical damage, 3 color versions. | Qualität der Verarbeitung. Starke Gehäuse. Schutz der Kabel vor mechanischen Beschädigungen in 3 Farbvarianten.



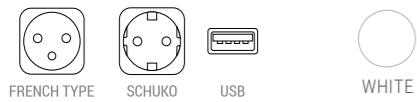
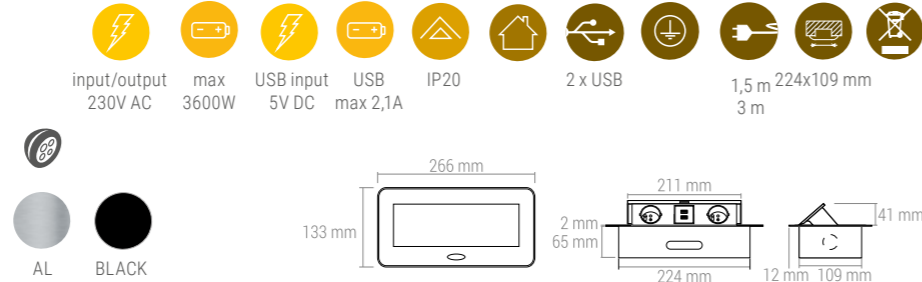

228. KOMBI BOX USB Z 1,5 M/ 3 M PRZEWODEM I WTYCZKĄ Z UZIEMIENIEM | KOMBI BOX USB WITH 1,5 M/ 3 M LEITUNGSKABEL UND ERDUNGSSTECKER



Indeks | Index | Index 2 x FRENCH TYPE, 2 x USB, 1,5 m: KOMB-()-2FR-USB-1,5-M1W

Indeks | Index | Index 2 x SCHUKO, 2 x USB, 1,5 m: KOMB-()-2DE-USB-1,5-M1W

Indeks | Index | Index 2 x FRENCH TYPE, 2 x USB, 3 m: KOMB-()-FR-3,0-M02

Indeks | Index | Index 2 x SCHUKO, 2 x USB, 3 m: KOMB-()-2DE-USB-M1W

229. INBOX

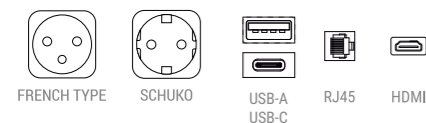
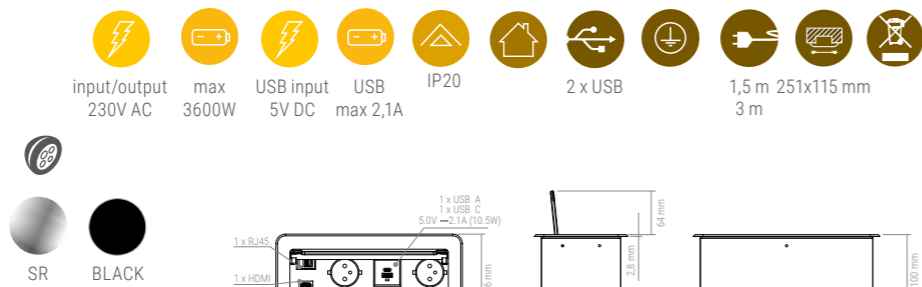

Indeks | Index | Index 2 x FRENCH TYPE, 2 x USB, 1,5 m: INBOX-()-FR-1,5-02

Indeks | Index | Index 2 x FRENCH TYPE, 2 x USB, 3 m: INBOX-()-FR-3,0-02

Indeks | Index | Index 2 x SCHUKO, 2 x USB, 1,5 m: INBOX-()-DE-1,5-02

Indeks | Index | Index 2 x SCHUKO, 2 x USB, 3 m: INBOX-()-DE-3,0-02

230. FLAT BOX USB

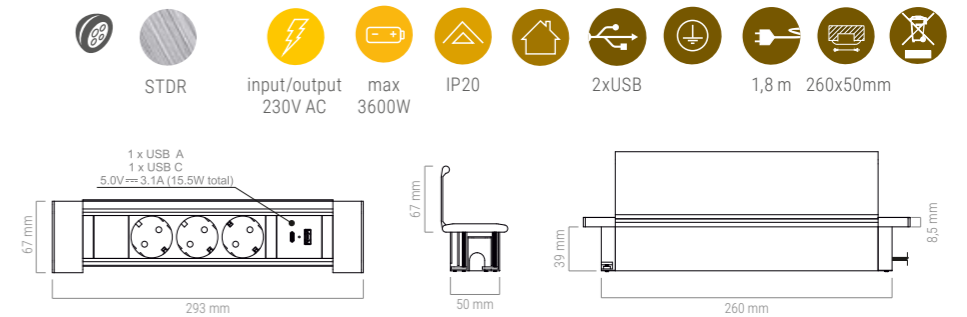

Indeks | Index | Index: FLATBOX-SD-3DE-UAC-01

231. FLAT BOX

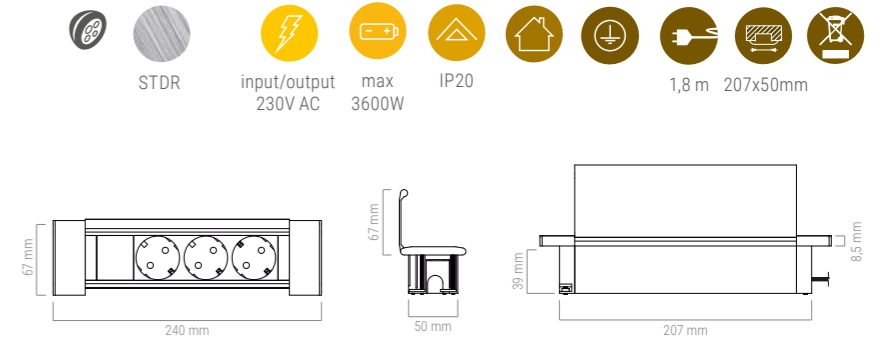
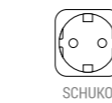

Indeks | Index | Index: FLATBOX-SD-3DE-01

232. HOP BOX

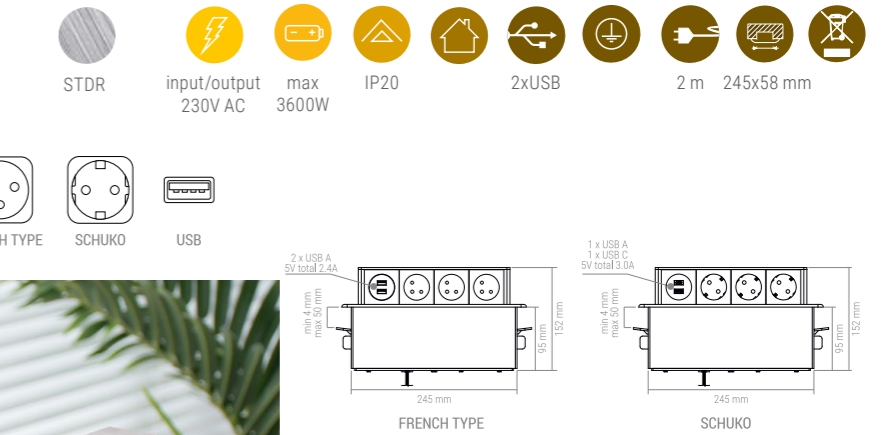
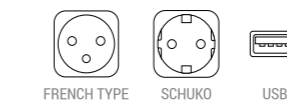

Indeks | Index | Index 3 x FRENCH TYPE: HOPBOX-SD-3FR-U-2-01
Indeks | Index | Index 3 x SCHUKO: HOPBOX-SD-3DE-UC-2-01



233. LIFT BOX

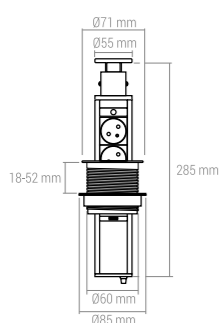

Zeskanuj kod smartfonem i zobacz film jak to działa
Scan QR code with a smartphone and watch a video of how it works.
Scannen Sie den Code QR mit Ihrem Smartphone und sehen Sie sich das Video an, wie es funktioniert.
Сканируйте QR-код своим смартфоном и посмотрите, как это работает.

Indeks | Index | Index 3 x FRENCH TYPE: LIFTBOX-()-3FR-01

Indeks | Index | Index 3 x SCHUKO: LIFTBOX-()-3DE-01

Indeks | Index | Index 3 x UK TYPE: LIFTBOX-()-3UK-01

234. LIFT BOX USB

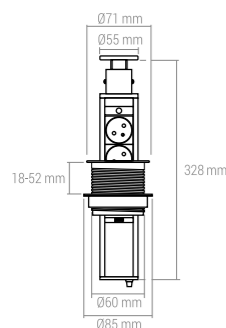
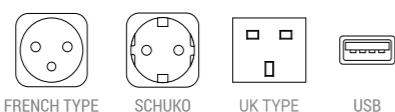
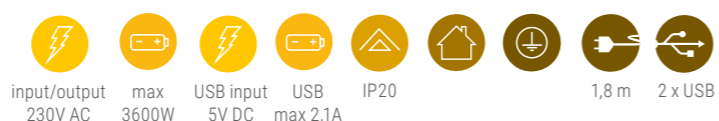

Zeskanuj kod smartfonem i zobacz film jak to działa.
Scan QR code with a smartphone and watch a video of how it works.
Scannen Sie den Code QR mit Ihrem Smartphone und sehen Sie sich das Video an, wie es funktioniert.

Indeks | Index | Index 3 x FRENCH TYPE, 2 x USB: LIFTBOX-()-3FR-U-01

Indeks | Index | Index 3 x SCHUKO, 2 x USB: LIFTBOX-()-3DE-U-01

Indeks | Index | Index 3 x UK TYPE, 2 x USB: LIFTBOX-()-3UK-U-01

235. LIFT BOX USB AUTOMATYCZNY | AUTOMATIC | AUTOMATISCH

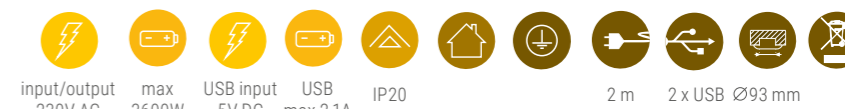
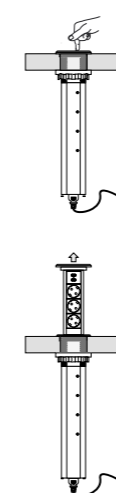

Sposób użycia urządzenia:
1. **Uruchomienie urządzenia** – dotknięcie symbolu wyłącznika przez około 2 sekundy – podświetlenie symbolu na zielono.
2. **Wysunięcie urządzenia** – aby wysunąć LIFT BOX należy dotknąć podświetlonego symbolu wyłącznika.
3. **Opuszczenie gniazda** – krótkie dotknięcie symbolu, gdy symbol wyłącznika jest podświetlony (urządzenie aktywne) lub długie dotknięcie symbolu około 2 s, gdy urządzenie jest nieaktywne (brak podświetlenia symbolu), a następnie krótkie dotknięcie, aby opuścić gniazda.
4. **Zatrzymanie urządzenia w trakcie wysuwania lub opuszczania** – dotknięcie symbolu w trakcie procesu podnoszenia lub opuszczania.
5. **Uwaga.** Jeśli urządzenie w trakcie wysuwania lub opuszczania gniazda i napotka przeszkodę, automatycznie się zatrzyma.

User's manual of the device:
1. **Starting the device** - touch the on/off symbol for approx. 2 seconds - the switch symbol will light up green.
2. **Eject device** - to eject the LIFT BOX touch the illuminated on/off switch symbol.
3. **Hiding the socket** - short touch of the symbol when the symbol of the switch is illuminated (active device) or long touch of the symbol for about 2 seconds, when the device is inactive (symbol is not illuminated) and then a short touch to hide the socket.
4. **Stopping the device while ejecting or hiding** - touch the symbol during the ejection or hiding process.
5. **Note.** If the device detects an obstacle while ejecting or hiding, it will automatically stop.

Gebrauchsanweisung des Gerätes:
1. **Starten des Gerätes** - Berühren Sie das Symbol des Schalters für ca. 2 Sekunden - Symbolbeleuchtung leuchtet in grün.
2. **Ausfahren des Gerätes** - zum Ausfahren der LIFT BOX sollte das Symbol des beleuchteten Schalters berührt werden.
3. **Versenken der Steckdosen** - kurze Berührung des Symbols wenn das Schaltersymbol leuchtet (Gerät aktiviert) oder Berührung des Symbols für ca. 2 Sekunden bei deaktiviertem Gerät (keine Symbolbeleuchtung), dann nochmals kurzes Berühren des Symbols um die Steckdosen zu versenken.
4. **Stoppen des Gerätes während des Ausfahrens oder Versenkens** - berühren Sie das Symbols während des Auffahr- oder Versenkvorgangs.
5. **Hinweis.** Wenn das Gerät während des Ausfahrens und Versenkens auf ein Hindernis trifft, wird es automatisch gestoppt.



Zeskanuj kod smartfonem i zobacz film jak to działa.
Scan QR code with a smartphone and watch a video of how it works.
Scannen Sie den Code QR mit Ihrem Smartphone und sehen Sie sich das Video an, wie es funktioniert.

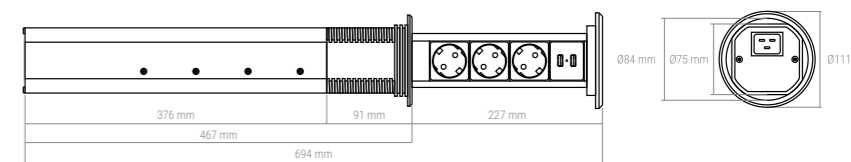

Indeks | Index | Index 3 x SCHUKO, 2 x USB: LIFTBOX-A-()-3DE-U-01

236. LIFT BOX USB AUTOMATYCZNY Z ŁADOWARKĄ INDUKCYJNĄ | AUTOMATIC WITH INDUCTIVE CHARGER | AUTOMATISCH MIT INDUKTIONS-LADEGERÄT

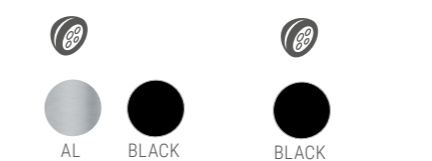
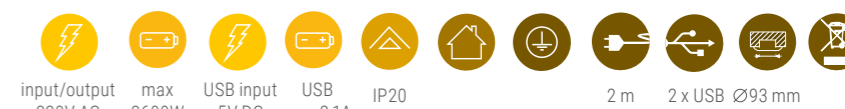

Zeskanuj kod smartfonem i zobacz film jak to działa.
Scan QR code with a smartphone and watch a video of how it works.
Scannen Sie den Code QR mit Ihrem Smartphone und sehen Sie sich das Video an, wie es funktioniert.

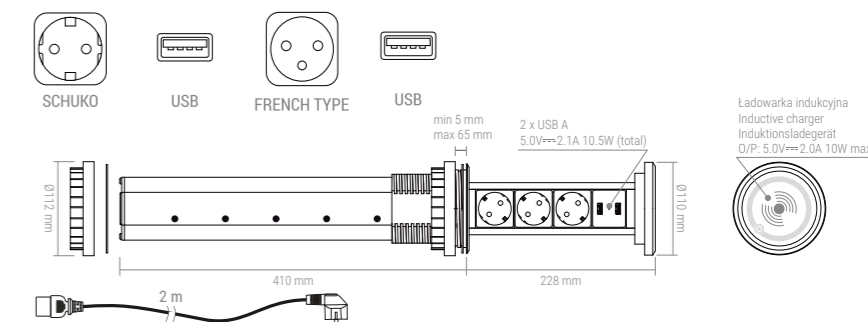

Indeks | Index | Index 3 x SCHUKO, 2 x USB: LIFTBOX-A-()-U-3DE-U-B-01

LIFTBOX-A-CZ-3FR-U-B-01

237. MULTI BOX

NOWOŚĆ! NEW! NEU!



4 x 230V AC
1 x USB A + 1 x USB C
2 x RJ45

BLACK
WHITE



input/output 230V AC max 3600W
USB input 5V DC
USB max 3,1A
IP20
1,7 m
2 x USB Ø122 mm

2 x RJ45
1 x USB A + 1 x USB C 5.0V→3.1A, 15.5W (total)
Ładowarka indukcyjna Inductive charger Induktionsladegerät Q/P: 5V DC, 5W max

FRENCH TYPE SCHUKO

USB-A
USB-C

RJ45

Indeks | Index | Index 4 x SCHUKO: MULTIBOX-()-4DE-UAC-RJ-01
Indeks | Index | Index 4 x FRENCH TYPE: MULTIBOX-()-4FR-UAC-RJ-01

238. TETRA BOX



4 x 230V AC

AL

input/output 230V AC max 3600W
IP20
1,4 m
Ø 100 mm

FRENCH TYPE SCHUKO

Indeks | Index | Index 4 x SCHUKO: TETRABOX-4G-DE-01
Indeks | Index | Index 4 x FRENCH TYPE: TETRABOX-4G-FR-01

239. TETRA BOX USB



3 x 230V AC + 2 x USB

AL

input/output 230V AC max 3600W
USB input 5V DC
USB max 2,4A
IP20
1,4 m
2 x USB Ø 100 mm

FRENCH TYPE SCHUKO

USB

Indeks | Index | Index 3 x SCHUKO, 2 x USB: TETRABOX-4G2U-DE-01
Indeks | Index | Index 3 x FRENCH TYPE, 2 x USB: TETRABOX-4G2U-FR-01

240. SINGLE BOX USB

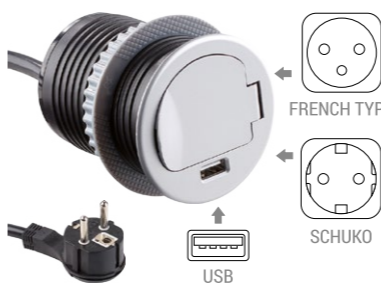

input/output 230V AC max 3600W
USB input 5V DC
USB max 2,4A
IP20
1,8 m
1 x USB Ø 60 mm

FRENCH TYPE SCHUKO

USB

AL BLACK

Indeks | Index | Index 1 x SCHUKO, 1 x USB AL: SINGLEBOX-1G1U-DE-01
Indeks | Index | Index 1 x SCHUKO, 1 x USB BLACK: SINGLEBOX-1G1U-DE-CZ-01
Indeks | Index | Index 1 x FRENCH TYPE, 1 x USB AL: SINGLEBOX-1G1U-FR-01
Indeks | Index | Index 1 x FRENCH TYPE, 1 x USB BLACK: SINGLEBOX-1G1U-FR-CZ-01

241. SLIDE BOX USB



input/output 230V AC max 3680W
USB input 5V DC
USB max 2,4A
IP20
1,9 m
1 x USB Ø 60 mm

FRENCH TYPE SCHUKO

USB

STDR BLACK

Indeks | Index | Index 1 x SCHUKO, 1 x USB STDR: SLIDEBOX-1G1U-DE-01
Indeks | Index | Index 1 x SCHUKO, 1 x USB BLACK: SLIDEBOX-1G1U-DE-CZ-01
Indeks | Index | Index 1 x FRENCH TYPE, 1 x USB STDR: SLIDEBOX-1G1U-FR-01
Indeks | Index | Index 1 x FRENCH TYPE, 1 x USB BLACK: SLIDEBOX-1G1U-FR-CZ-01

242. EIGHTBOX



input/output 230V AC max 3600W
IP20
1 m
135x60 mm

STDR BLACK
WHITE

FRENCH TYPE

Obrotowa przestona z metalu.

Indeks | Index | Index: EIGHTBOX-()-2FR-01

243. EIGHTBOX USB



Obrotowa przesłona z metalu.

STDR BLACK
WHITE

input/output 230V AC max 3600W
USB input 5V DC max 1A
IP20
1 x USB 1 m 135x60 mm

FRENCH TYPE USB

Ø130 mm 71 mm 146 mm 457 mm 15-40 mm 59 mm 76 mm

Indeks | Index | Index: EIGHTBOX-()-1FR-1U-01



244. SAMBO BOX

BLACK

input/output 230V AC max 3600W
USB input 5V DC max 2,4A
IP20
1,8 m 2 x USB Ø80 mm

Zeskanuj kod smartfonem i zobacz film jak to działa.
Scan QR code with a smartphone and watch a video of how it works.
Scannen Sie den Code QR mit Ihrem Smartphone und sehen Sie sich das Video an, wie es funktioniert.

Ładowarka indukcyjna Inductive charger Induktionsladegerät O/P: 5V DC, 5W max.
1 x USB A 1 x USB C 5.0V ~ 2.4A (12.0W)

FRENCH TYPE SCHUKO USB

96 mm 82 mm min 5 mm max 50 mm 078 mm

Indeks | Index | Index 1 x SCHUKO: SAMBOBOX-CZ-DE-U-2-01
Indeks | Index | Index 1 x FRENCH TYPE: SAMBOBOX-CZ-FR-U-2-01

Dodatkowe akcesoria:
Additional accessories | Zusätzliches Zubehör

Indeks | Index | Index HDMI: SAMBOBOX-MOD-CZ-HD-01
Indeks | Index | Index RJ45: SAMBOBOX-MOD-CZ-RJ-01
Indeks | Index | Index USB: SAMBOBOX-MOD-CZ-U-01

245. ŁADOWARKA 2 X USB WPUSZCZANA DO PŁYTY MEBLOWEJ | 2 x USB CHARGER RECESSED INTO FURNITURE BOARD
| 2 x USB EINBAULADEGERÄT FÜR MÖBELPLATTEN



USB

input 12V DC output 5V DC
USB max 2,1A
IP20
2 x USB 2 m mini konektor Ø25 mm

Ładowarka USB montowana w płycie meblowej. Posiada 2 gniazda USB, do których można podłączyć np. smartfon, tablet lub inne urządzenie zasilane USB.
USB charger mounted in furniture board. It has 2 USB ports to which you can connect your smartphone, tablet or other USB-powered device.
USB-Ladegerät in Möbelplatte montiert. Es verfügt über 2 USB-Anschlüsse, an die Sie z.B. Ihr Smartphone, Tablett oder ein anderes USB Gerät anschließen können.

W celu uzyskania najlepszej wydajności ładowania zaleca się podłączenie do zasilacza 12V DC o mocy min. 25 - 30W.
For best charging performance, we recommend connecting a 12V DC power supply unit with a min. power rating. 25 - 30W.
Für eine optimale Ladeleistung empfehlen wir den Anschluss eines 12V DC Netzteils mit einer Mindestleistung. 25 - 30W.

Zeskanuj kod smartfonem i zobacz film jak to działa.
Scan QR code with a smartphone and watch a video of how it works.
Scannen Sie den Code QR mit Ihrem Smartphone und sehen Sie sich das Video an, wie es funktioniert.

1x USB A 1x USB C 5.0V ~ 2,1A (10,5W)

37 mm 31 mm 2 m 12V DC

Indeks | Index | Index: GNI-USB-CZ-03

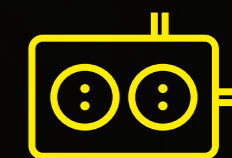

CZUJNIKI RUCHU I ZMIERZCHU

MOTION AND DUSK
SENSORS
BEWEGUNGS-
UND DÄMMERUNGS-
SENSOREN



246. CZUJNIK RUCHU PIR MODEL 1 NAŚCIENNY | PIR MODEL 1 WALL-MOUNTED MOTION DETECTOR | PIR MODELL 1 WAND-BEWEGUNGSMELDER

IP65

BLACK WHITE

230V AC max 1200W IP65

80 mm 119 mm 51 mm PIR 2 PIR 1

180° 1,8 - 2,5 m 360° ON/OFF 12 m max

2 wbudowane sensory ruchu: 180 i 360 stopni, maksymalny zasięg detekcji: 12 m, możliwość regulacji czujnika w 2 płaszczyznach, ustawienie progu czułości zmierzchowej (od 3 do 2000 LUX), ustawienie czasu świecenia / pracy (10 sek. do 15 min.).

2 built-in sensors: 180 and 360 degrees, maximum detection range: 12 m, the sensor can be adjusted in two directions, setting the twilight sensitivity threshold (from 3 to 2000 LUX), setting of lighting / work time adjustment (10 sec. To 15 min.).

2 eingebaute Sensoren: 180 und 360 Grad, maximaler Erfassungsbereich: 12 m, Möglichkeit der Sensoreinstellung in 2 Ebenen, Einstellung der Dämmerungsempfindlichkeitsschwelle (von 3 bis 2000 LUX), Einstellung der Beleuchtungszeit / Arbeitszeit (10 Sek. bis 15 Min.).

Indeks | Index | Index: WYL-CR-M1-()-01

247. CZUJNIK RUCHU PIR MODEL 3 SUFITOWY | PIR MODEL 3 CEILING MOTION DETECTOR | PIR MODELL 3 DECKEN-BEWEGUNGSMELDER

IP65

WHITE

230V AC max 2000W IP65

59 mm 102 mm 102 mm

360° ON/OFF 20 m max

Wbudowany sensor ruchu i obecności: 360 stopni, maksymalny zasięg detekcji: 20 m, ustawienie progu czułości zmierzchowej (od 3 do 2000 LUX), ustawienie czasu świecenia / pracy (10 sek. do 30 min.).

Built-in sensor: 360 degrees, maximum detection range: 20 m, setting the twilight sensitivity threshold (from 3 to 2000 LUX), setting of lighting / working time (10 sec. To 30 min.).

Eingebauter Sensor: 360 Grad, maximaler Erfassungsbereich: 20 m, Einstellung der Dämmerungsempfindlichkeitsschwelle (von 3 bis 2000 LUX), Einstellung der Beleuchtungszeit / Arbeitszeit (10 Sek. bis 30 Min.).

Indeks | Index | Index: WYL-CR-M3-BI-01

248. CZUJNIK ZMIERZCHU MODEL 4 DO SZYNY W ROZDZIELNI ELEKTRYCZNEJ | DUSK SENSOR MODEL 4 DEDICATED FOR MOUNTING ON A RAIL IN THE ELECTRICAL SWITCHBOARD | DÄMMERUNGSSENSOR MODELL 4 FÜR SCHIENE IN ELEKTRISCHER SCHALTANLAGE

IP65 IP20

GREY

230V AC max 3000W IP20 IP65

35 mm 66 mm 90 mm 20 mm 35 mm 950 mm

Ustawienie progu czułości zmierzchowej (od 2 do 100 LUX), podwyższony stopień ochrony IP65 dla fotokomórki, wymiary otworu montażowego Ø10 mm dla fotokomórki, montaż w szynie DIN 35 mm.

Setting the twilight sensitivity threshold (from 2 to 100 LUX), increased protection class IP65 for the photocell, dimensions of the mounting hole Ø10 mm for the photocell, installation in a 35 mm DIN rail.

Einstellung der Dämmerungsempfindlichkeitsschwelle (von 2 bis 100 LUX), Erhöhte Schutzklasse IP65 für die Fotozelle, Abmessungen der Montagebohrung Ø10 mm für die Fotozelle, Montiert auf einer Schiene DIN 35 mm.

Indeks | Index | Index: WYL-CR-M4-SZ-01



Dane techniczne | Technical data | Technische Daten

- 
1. Urządzenie zasilane napięciem...V(AC/DC) | Device powered with...V AC or DC voltage | Stromversorgungsgerät...V(AC/DC)
- 
2. Moc maksymalna | Max power | Maximalleistung
- 
3. Stopień ochrony IP, zapewniany przez obudowę urządzenia | International Protection IP | Schutzgrad
- 
4. Przykładowa klasa energetyczna | Exemplary energetic class | Beispiel einer Energieeffizienzklasse
- 
5. Typ diod zastosowanych w taśmach LED | Type of diodes used in LED strips | Verwendete LED Dioden in Strips
- 
6. Minimalna odległość od źródła światła | Minimum distance from the light source | Minimale Abstand der Lichtquelle
- 
7. Wymiary otworu montażowego | Dimensions of mounting hole | Maße der Montagebohrungen
- 
8. Oprawa ruchoma-możliwość regulacji kąta świecenia | Swing luminaire-adjustable angle of illumination | Gehäuse schwenkbar, mit regulierenden Lichtwinkel
- 
9. Wyłącznik dotykowy | Touch switch | Berührungsschalter
- 
10. Wyłącznik ruchowy PIR na podczerwień | PIR switch | Bewegungsschalter mit Infrarot
- 
11. Wyłącznik zbliżeniowy IR na podczerwień | IR switch | Näherungsschalter mit Infrarot
- 
12. Zasięg pilota | Remote control range | Reichweite des Piloten
- 
13. Źródło światła-żarówka GU10 | Light source GU10 bulb | Lichtquelle – Glühlampe GU10
- 
14. Źródło światła-szyft LED SMD G4 | Light source LED SMD G4 pin | Lichtquelle Stift LED SMD G4
- 
15. Transformator bezpieczeństwa, odporny na zwarcie | Safety transformer resistant to short-circuit | Transformator bedingt beständig gegen Kurzschluss
- 
16. Współczynnik mocy | Power factor | Leistungsfaktor
- 
17. Produkt dostosowany do instalacji w meblach wymagane VDE | Equipment fit for installation on furniture (for mounting on unspecified areas) | Geeignet für den Einbau in an Möbeln (VDE erforderlich)
- 
18. Maksymalna temperatura pracy, przy której włączy się zabezpieczenie termiczne | Maximum operating temperature at which the thermal protection is activated | Maximale Betriebstemperatur, bei der der thermische Schutz aktiviert wird
- 
19. I klasa ochronności z podstawową izolacją wąskich części, ale także z uzupełniającymi zabezpieczeniami opartymi na połączeniach części przewodów z dostępem do ochronnego przewodu (uziemia) przynależącego do zainstalowanego urządzenia | Class protection. Equipment with fundamental insulation of the tight parts but also with a supplementary security based on the connection of the conductors parts with access to a protection conductor (earthing) belonging to the fixed plant | 1 Schutzklasse der Grundisolierung schmaler Teile, aber auch mit ergänzender Sicherheit basierend auf den Anschlüssen der Kabel (Erdung) mit Zugang auf die Installierten Geräte
- 
20. II klasa ochronności. Ochrona zapewniona przez zastosowanie podwójnej lub wzmocnionej izolacji | II Class protection. Provided by double or reinforced insulation | 2 Schutzklasse. Versicherter Schutz durch die Verwendung doppelter oder verstärkter Isolierung

Niniejszy katalog nie stanowi oferty w rozumieniu prawnym i jest publikowany jedynie w celach informacyjnych!
 Design Light Sp. z o.o. zastrzega sobie prawo do zmiany oferty katalogowej.
 Design Light Sp. z o.o. zastrzega sobie prawo do zmian technicznych i technicznej charakterystyki prezentowanych produktów.
 Aktualne informacje na stronie internetowej lub w biurze handlowym.
 Wszystkie produkty z tego katalogu są zgodne z CE i RoHS.

Pracownicy naszej firmy dołożyli wszelkich możliwych starań, aby prezentowane w katalogu informacje były prawdziwe i aktualne, jednak nie mogą tego zagwarantować.
 Dlatego błędne informacje nie mogą być podstawą do roszczeń.
 W przypadku jakichkolwiek wątpliwości prosimy przed podjęciem decyzji o kontakt z pracownikiem firmy.

Dane techniczne | Technical data | Technische Daten

21. III klasa ochronności. Ochrona zapewniona przez zasilanie urządzenia bardzo niskim napięciem bezpiecznym SELV (<50 V AC) lub PELV (<120 V DC) | III Class protection. Provided by power supply of a very low voltage SELV (<50 V AC) or PELV (<120 V DC) | 3 Schutzklasse. Versichert Schutz durch die Stromversorgung mit sehr niedriger Sicherheits-Spannung <50V oder 120V AC



22. Długość przewodu bez wtyczki | Wire length without plug | Kabellänge ohne Stecker



23. Długość przewodu z wtyczką MINI-KONEKTOR | Wire length with a MINI-KONEKTOR plug | Kabellänge mit MINI-Steckverbinder



24. Długość przewodu z wtyczką EURO | Wire length with an EURO plug | Kabellänge mit Eurostecker



25. Wtyczka EURO | EURO plug | Euro-Stecker



26. Długość przewodu z wtyczką MINI RGB | Wire length with a MINI RGB plug | Kabellänge mit MINI RGB Stecker



27. Długość przewodu z wtyczką JACK | Wire length with a JACK plug | Kabellänge mit JACK Stecker



28. Ilość portów USB | Number of USB ports | Anzahl der USB-Anschlüsse



29. Europejskie normy potwierdzone znakiem bezpieczeństwa CE | UE norms confirmed by the CE certificate | Europäische Normen bestätigt durch das Sicherheitszeichen CE



30. Certyfikat jakości i bezpieczeństwa produktu przeprowadzony przez niezależne biuro badawcze | Certificate of Technical Inspection Association which refers to product safety and quality | Zertifikat der Produktqualität und Sicherheit wurde durchgeführt von einem unabhängigen Forschungsbüro



31. Certyfikat potwierdzający bezpieczeństwo wyrobów i urządzeń | Certificate confirming Equipment and Product Safety | Zertifikat der Sicherheit von Erzeugnissen und Geräten



32. Urządzenie dopuszczone do montażu w bezpośrednim kontakcie z materiałami o normalnym stopniu palności | Device permissible for installation in a direct contact with materials estimated to group of normal combustibility | Gerät geeignet für den An-Einbau an bzw. in entflammaren Materialien elektromagnetische Verträglichkeit



33. Kompatybilność elektromagnetyczna | Electromagnetic compatibility | Elektromagnetische Verträglichkeit



34. Bezpieczne urządzenie bardzo niskiego napięcia | Safety extra low voltage | Sicherheitskleinspannung



35. Do użytku wyłącznie wewnętrznego | For indoor use only | Nur für innen



36. Do użytku wewnętrznego i zewnętrznego | For indoor and outdoor use | Für den Innen- und Außenbereich



37. Wzór oznakowania sprzętu elektrycznego i elektronicznego wskazujący na selektywne zbieranie | Pattern of labeling an electrical and electronic equipment which indicates a separate collecting | Musterkennzeichnung elektrischer und elektronischer Geräte für getrennte Sammlung



38. Przekrój żyły przewodu | Wire cross section | Kabelquerschnittsfläche



39. Parametry pracy wyłącznika | Switch working parameters | Betriebsparameters der Schalter



40. Dopuszczalna szerokość taśmy LED w profilu | Permissible LED strip width in the profile | Zulässige Breite des LED-Streifens im Profil

Kolory kloszy | Diffuser colors | Abdeckung farben

41. **Transparentny** | Transparent | Durchsichtig



42. **Mleczny** | Opal | Opal



43. **Czarny** | Black | Schwarz

Barwy światła | Light colors | Lichtfarben

44. **Biała zimna** | Cool white | Kaltweiß



45. **Biała ciepła** | Warm white | Warmweiß



46. **Biała neutralna** | Neutral white | Neutralweiß



47. **Czerwona** | Red | Rot



48. **Zielona** | Green | Grün



49. **Niebieska** | Blue | Blau



50. **RGB**

Kolory produktów | Colors of products | Farben der Produkte

51. **Aluminium** | Aluminium | Aluminium



52. **Gold** | Gold | Gold



53. **Antyk** | Antique | Antik



54. **Biały** | White | Weiß



55. **Stal drapana** | Brushed steel | Edelstahl gebürstet



56. **Srebrny** | Silver | Silber



57. **Szary** | Grey | Grau



58. **Chrom** | Chrome | Chrom



59. **Czarny** | Black | Schwarz



60. **Brązowy** | Brown | Braun



61. **Czarny kryształ** | Black crystal | Schwarze Kristall



62. **Biały kryształ** | White crystal | Weiße Kristall



Wszystkie produkty katalogu, zawierające kod QR, dają możliwość obejrzenia filmu prezentacyjnego online. Wystarczy zainstalować aplikację do kodów QR na smartfona lub tablet po czym zeskanować kod. | All products containing QR Code give the opportunity to watch a movie online. Just install application for QR codes on your smartphone or tablet then scan code. | Alle Produkte aus Unserem Katalog mit QR Code, ermöglichen eine Filmpräsentation online anzusehen. Einfach Anwendung Für QR Codes auf Smartphone oder Tablet installieren, dann Code scannen.



DESIGN LIGHT SPÓŁKA Z O.O.
ul. Wrocławska 1B, 48-340 Głuchołazy, POLSKA
bh@designlight.pl | www.designlight.pl
export@designlight.eu | www.designlight.eu

Detal/Sklep: +48 603 983 727
Polska Zachodnia: +48 531 690 270
Polska Wschodnia: +48 531 650 240
 +48 574 550 655  +48 577 400 342

Dział Techniczny: +48 533 530 552
Dział Marketingu: +48 577 400 851
Wersja katalogu: 35, Rok wydania: 2023